

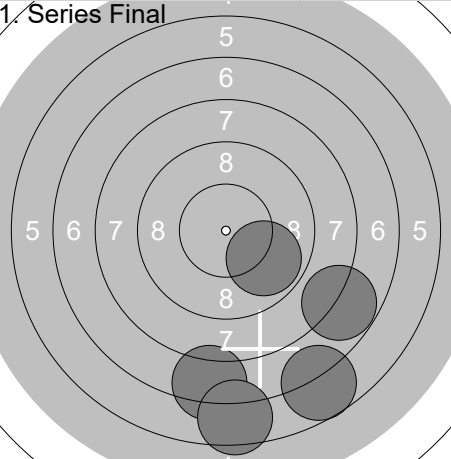
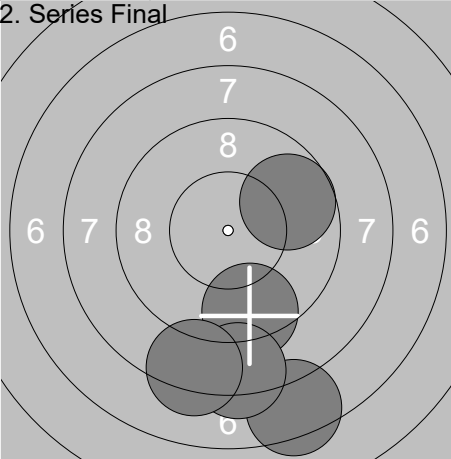
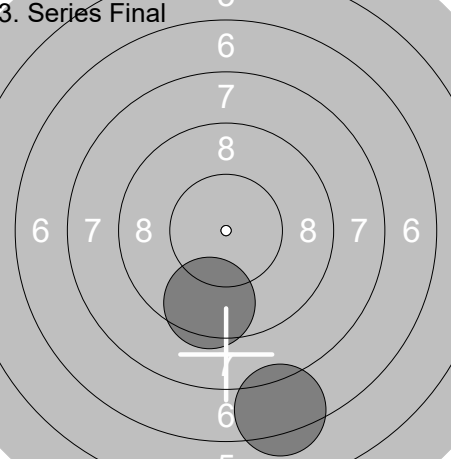
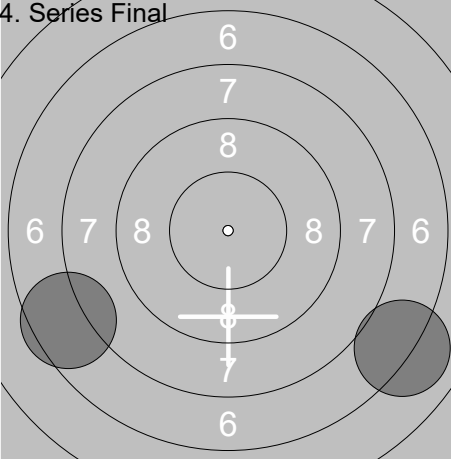

| Relay   | Lane   | Janine Bradbury  |  |
|---|--|--|--|
| Wrexham   |  |  |  |
| 02.04.2017  | Rifle Senior   | Welsh Airgun Association   |  |
| 1. Series Final   | 1: 6.7 ↘<br>2: 7.3 ↓<br>3: 9.8 ↘<br>4: 7.8 ↘<br>5: 6.5 ↓ | 2. Series Final  | 1: 7.4 ↓<br>2: 9.4 ↓<br>3: 9.7 →<br>4: 8.3 ↓<br>5: 8.3 ↓ |
|    | Series 38.1<br>38.1                                      |    | Series 43.1<br>81.2                                      |
| 3. Series Final   | 1: 9.5 ↓<br>2: 7.3 ↓                                     | 4. Series Final  | 1: 7.5 ←<br>2: 7.0 ↘                                     |
|   | Series 16.8<br>98.0                                      |   | Series 14.5<br>112.5                                     |
| 5. Series Final   | 1: 8.5 ↓<br>2: 8.0 ↓                                     | 6. Series Final  | 1: 8.3 ↓<br>2: 7.3 ↓                                     |
|  | Series 16.5<br>129.0                                     |  | Series 15.6<br>144.6                                     |
| 7. Series Final   | 1: 8.1 ↓<br>2: 4.9 ↓                                     | 8. Series Final  | 1: 7.5 →<br>2: 7.7 ←                                     |
|  | Series 13.0<br>157.6                                     |  | Series 15.2<br>172.8                                     |

| Relay           | Lane  | Rhian Floyd   |  |
|-----------------|---|---|--|
| Wrexham         |   |   |  |
| 02.04.2017      |   | Rifle Senior  | Welsh Airgun Association   |
| 1. Series Final |    | 1: 9.5 ↗<br>2: 10.6x →<br>3: 9.3 ↘<br>4: 9.7 ←<br>5: 10.0 → | 2. Series Final 6<br> 1: 8.5 ↗<br>2: 10.4x ←<br>3: 9.7 ↘<br>4: 8.1 →<br>5: 10.2x ↗ |
|                 |   | Series 49.1   | Series 46.9  |
|                 |   | 49.1  | 96.0   |
| 3. Series Final |   | 1: 9.5 →<br>2: 9.7 ↘  | 4. Series Final<br> 1: 9.8 →<br>2: 10.3x ←  |
|                 |   | Series 19.2   | Series 20.1  |
|                 |   | 115.2   | 135.3  |
| 5. Series Final |  | 1: 10.1 ↓<br>2: 9.3 →                                       | 6. Series Final<br> 1: 10.7x ↓<br>2: 9.4 ←                                       |
|                 |   | Series 19.4   | Series 20.1  |
|                 |   | 154.7   | 174.8  |
| 7. Series Final |  | 1: 8.4 ←<br>2: 9.9 ←  | 8. Series Final<br> 1: 9.4 ←<br>2: 9.7 ↙   |
|                 |   | Series 18.3   | Series 19.1  |
|                 |   | 193.1   | 212.2  |
| 9. Series Final |  | 1: 10.0 ↘<br>2: 10.9x ↑                                     |  |
|                 |   | Series 20.9   |  |
|                 |   | 233.1   |  |

|                   |   |   |  |
|-------------------|---|---|--|
| Relay<br><b>1</b> | Lane<br><b>16</b>   | <b>Paul Horbury</b>   |  |
| Wrexham           |   |   |  |
| 02.04.2017        |   | Rifle Senior  | Welsh Airgun Association   |
| 1. Series Final   |    | 1: 8.9 ←<br>2: 10.1 →<br>3: 8.6 ←<br>4: 9.0 ←<br>5: 10.5x ← | 2. Series Final  |
|                   | Series  | 47.1  | 1: 9.0 →<br>2: 10.6x ↑<br>3: 10.3x ↑<br>4: 10.7x →<br>5: 10.3x ↙ |
|                   |   | 47.1  | Series   |
|                   |   |   | 50.9   |
|                   |   |   | 98.0   |
| 3. Series Final   |    | 1: 10.7x ↖<br>2: 10.4x ↙                                    | 4. Series Final  |
|                   | Series  | 21.1  | 1: 9.8 ←<br>2: 9.9 ↙   |
|                   |   | 119.1   | Series   |
|                   |   |   | 19.7   |
|                   |   |   | 138.8  |
| 5. Series Final   |  | 1: 10.5x √<br>2: 10.0 ↗                                     | 6. Series Final  |
|                   | Series  | 20.5  | 1: 10.5x ←<br>2: 10.5x ↙   |
|                   |   | 159.3   | Series   |
|                   |   |   | 21.0   |
|                   |   |   | 180.3  |
| 7. Series Final   |  | 1: 9.3 →<br>2: 9.6 →  | 8. Series Final  |
|                   | Series  | 18.9  | 1: 10.9x ↖<br>2: 9.8 ↙   |
|                   |   | 199.2   | Series   |
|                   |   |   | 20.7   |
|                   |   |   | 219.9  |
| 9. Series Final   |  | 1: 9.8 →<br>2: 9.8 →  |  |
|                   | Series  | 19.6  |  |
|                   |   | 239.5   |  |

|   |                   |   |  |  |  |
|---|-------------------|---|--|--|--|
| Relay<br><b>1</b>   | Lane<br><b>12</b> | <b>BRADBURY Victoria</b>                                  |  |  |  |
| Wrexham   |                   | Rugeley   |  |  |  |
| 02.04.2017  |                   | Rifle Junior  |  | Welsh Airgun Association   |  |
| 1. Series Final   |                   | 1: 7.8 ↗<br>2: 8.3 ←<br>3: 7.2 ←<br>4: 9.2 ↓<br>5: 10.0 → |  | 2. Series Final  |  |
|    |                   | Series 42.5<br>42.5                                       |  |    |  |
|   |                   |   |  | 1: 10.3x ↘<br>2: 10.4x ↑<br>3: 10.5x ↗<br>4: 5.8 ←<br>5: 8.3 ←                       |  |
|   |                   |   |  | Series 45.3<br>87.8  |  |
| 3. Series Final   |                   | 1: 10.0 ←<br>2: 8.9 ↑                                     |  | 4. Series Final  |  |
|   |                   | Series 18.9<br>106.7                                      |  |   |  |
|   |                   |   |  | 1: 7.7 ←<br>2: 7.9 ←   |  |
|   |                   |   |  | Series 15.6<br>122.3   |  |
| 5. Series Final   |                   | 1: 7.6 ↓<br>2: 6.8 ←                                      |  | 6. Series Final  |  |
|  |                   | Series 14.4<br>136.7                                      |  |  |  |
|   |                   |   |  | 1: 7.3 ←<br>2: 7.8 ↓   |  |
|   |                   |   |  | Series 15.1<br>151.8   |  |
| 7. Series Final   |                   | 1: 6.9 ↗<br>2: 9.5 ←                                      |  |  |  |
|  |                   | Series 16.4<br>168.2                                      |  |  |  |

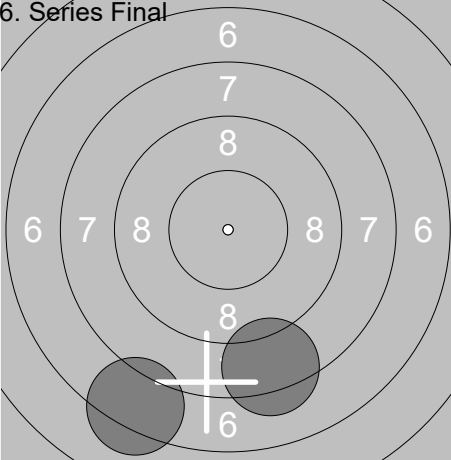
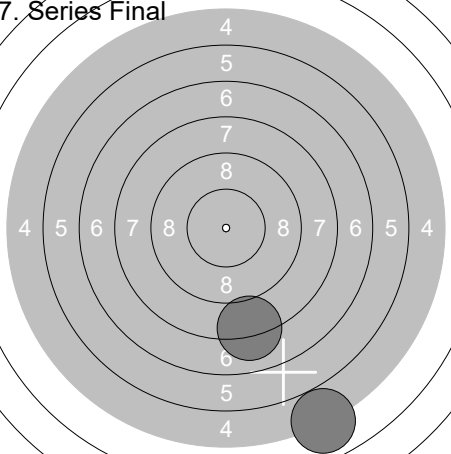
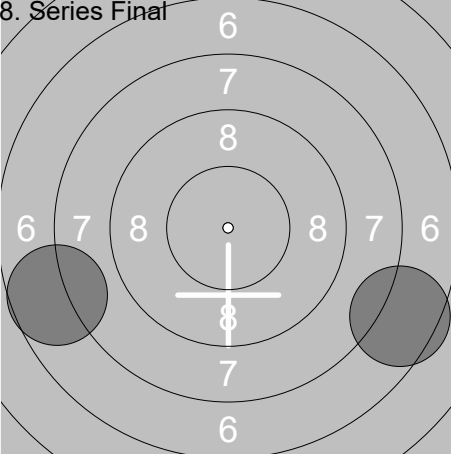
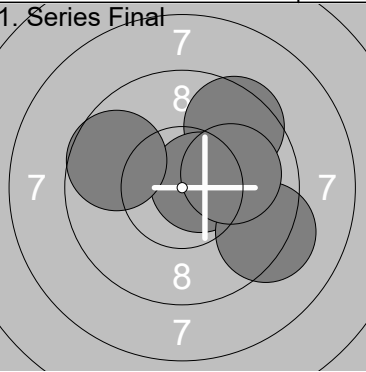
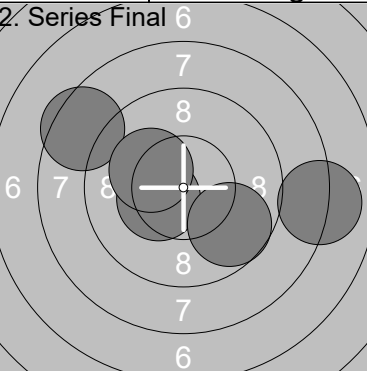
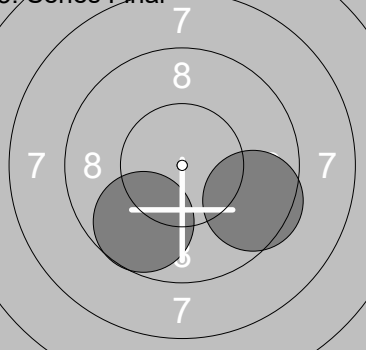
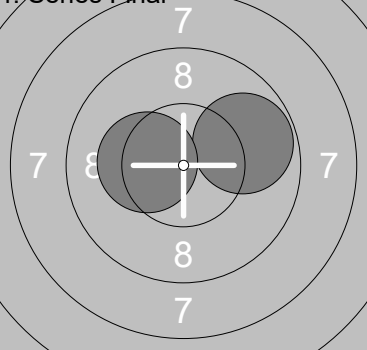
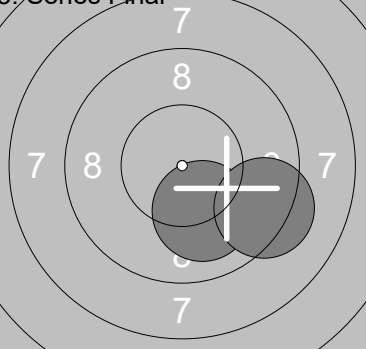
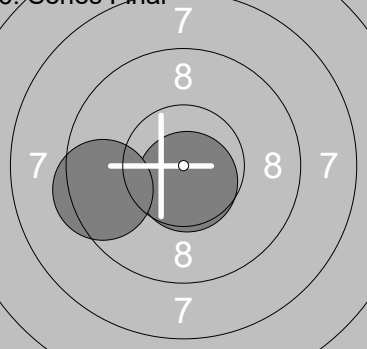
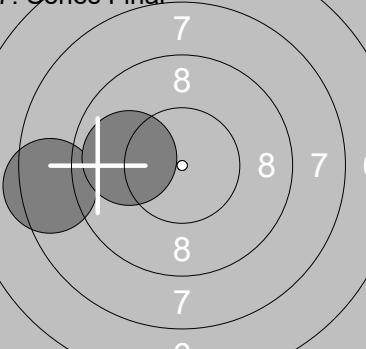
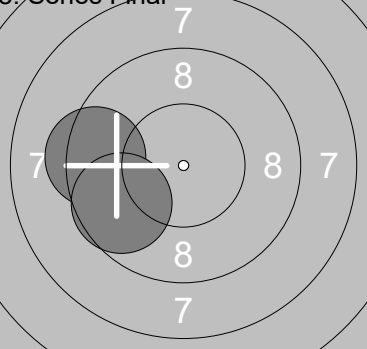
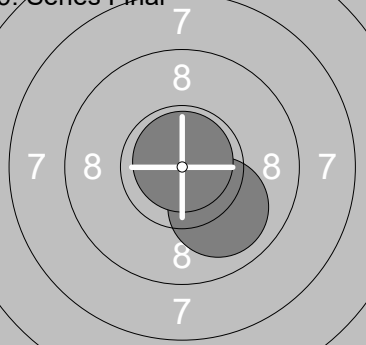
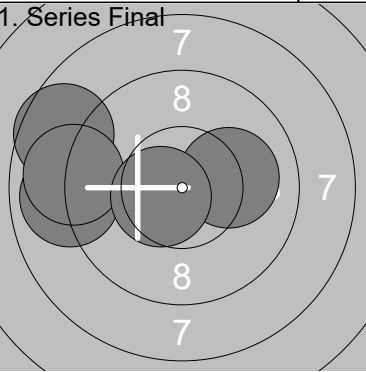
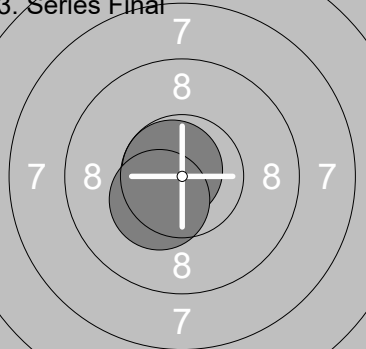
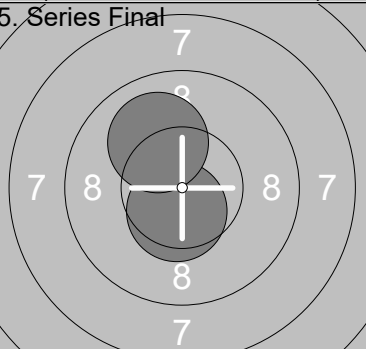
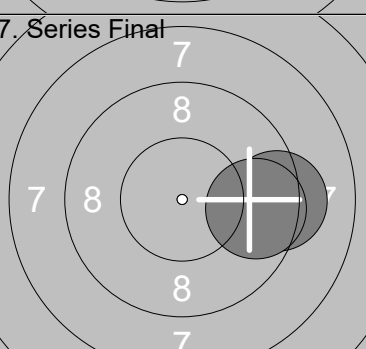
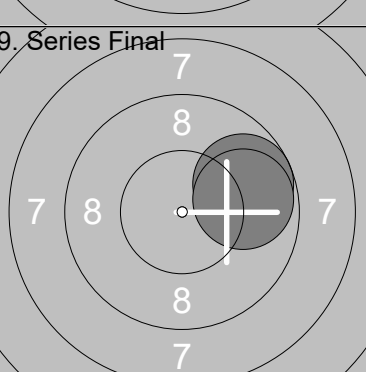
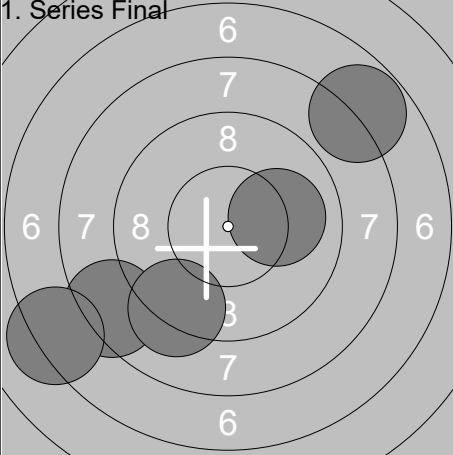
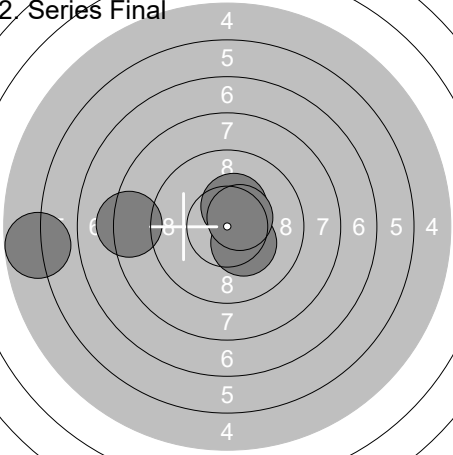
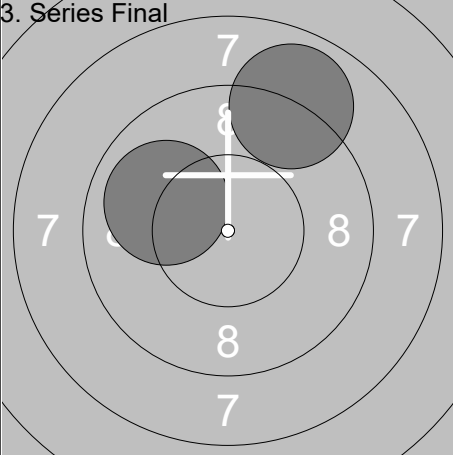
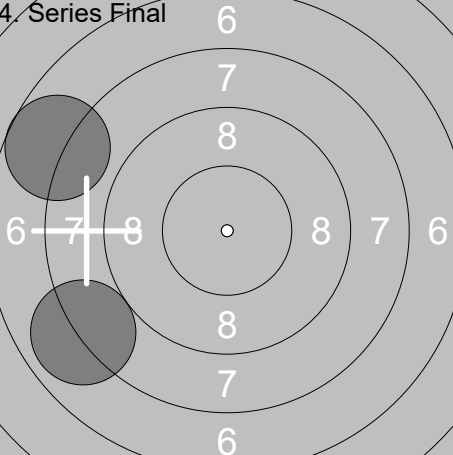
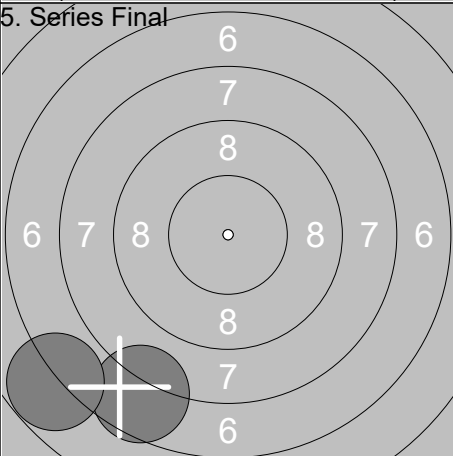
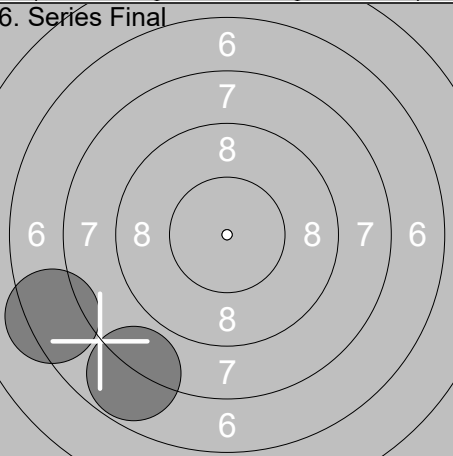
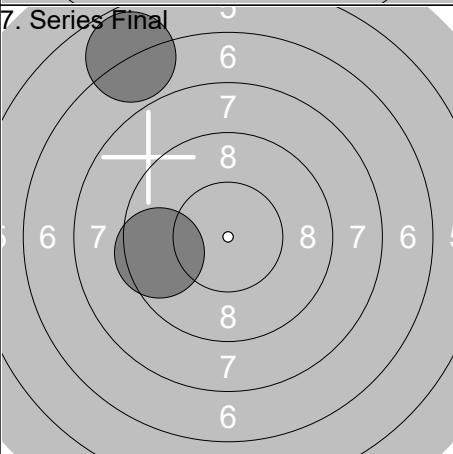
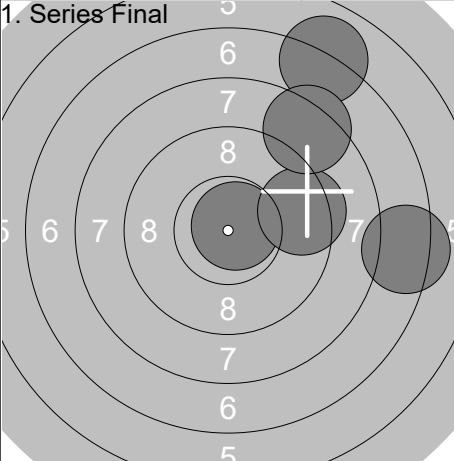
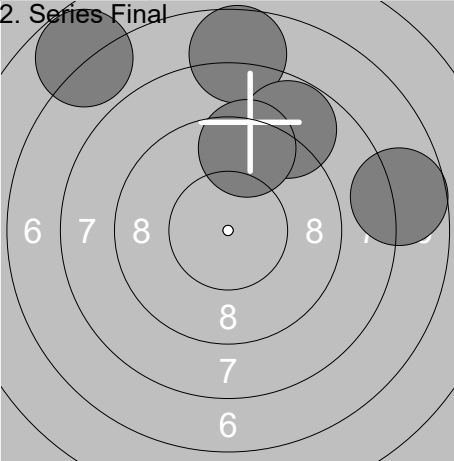
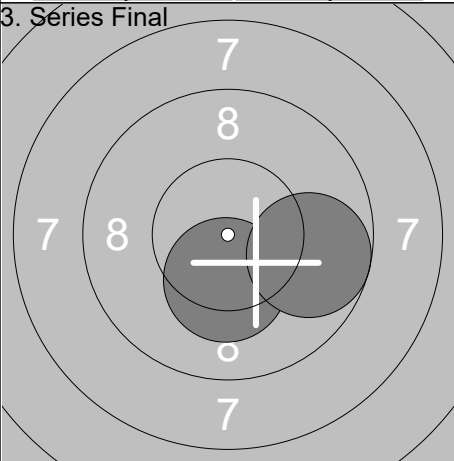
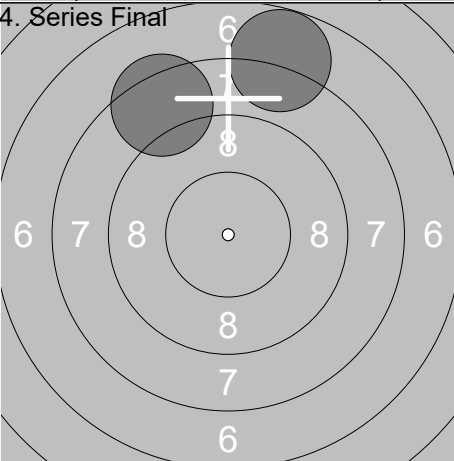
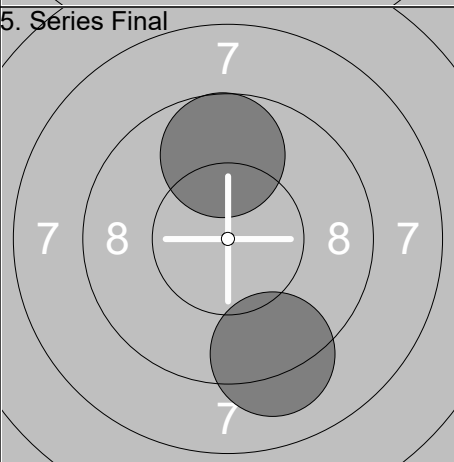
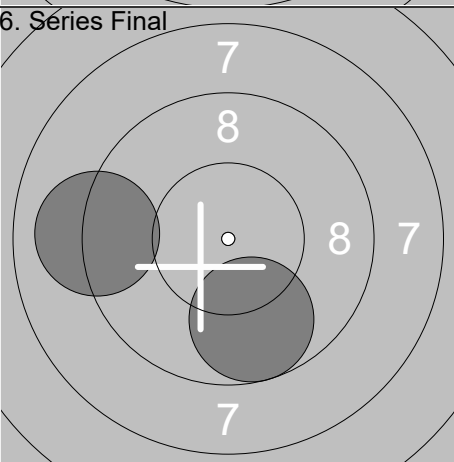
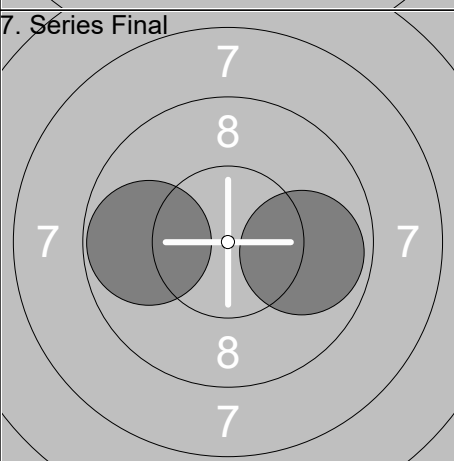
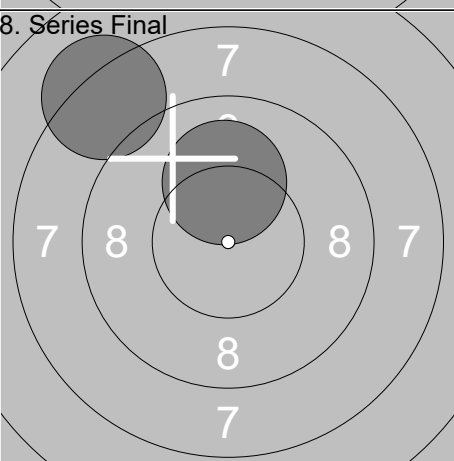
| Relay   | Lane   | HUGHES Dylan   |  |
|---|--|--|--|
| 1   | 13   |  |  |
| Wrexham   | WAA  |  |  |
| 02.04.2017  | Rifle Junior   | Welsh Airgun Association   |  |
| 1. Series Final   | 1: 10.8x →<br>2: 9.4 →<br>3: 7.3 →<br>4: 7.0 ↗<br>5: 8.4 ↗ | 2. Series Final  | 1: 7.7 ↑<br>2: 7.7 →<br>3: 8.8 ↗<br>4: 9.4 ↑<br>5: 6.8 ↖ |
|    | Series 42.9<br>42.9  |    | Series 40.4<br>83.3                                      |
| 3. Series Final   | 1: 10.3x ↓<br>2: 9.7 →                                     | 4. Series Final  | 1: 7.8 ↑<br>2: 8.4 ↖                                     |
|   | Series 20.0<br>103.3                                       |   | Series 16.2<br>119.5                                     |
| 5. Series Final   | 1: 9.2 ↓<br>2: 9.7 ↑                                       | 6. Series Final  | 1: 9.7 ↓<br>2: 9.1 ←                                     |
|  | Series 18.9<br>138.4                                       |  | Series 18.8<br>157.2                                     |
| 7. Series Final   | 1: 9.8 ←<br>2: 9.9 →                                       | 8. Series Final  | 1: 8.2 ↖<br>2: 10.1 ↑                                    |
|  | Series 19.7<br>176.9                                       |  | Series 18.3<br>195.2                                     |

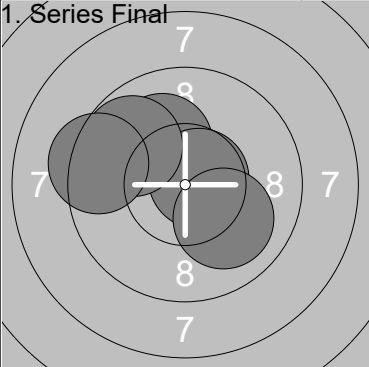
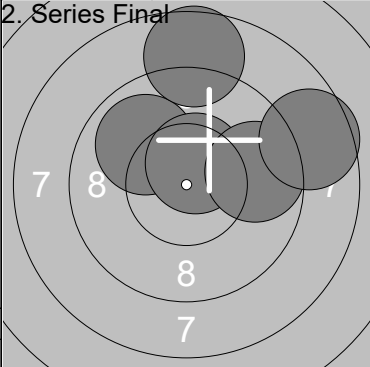
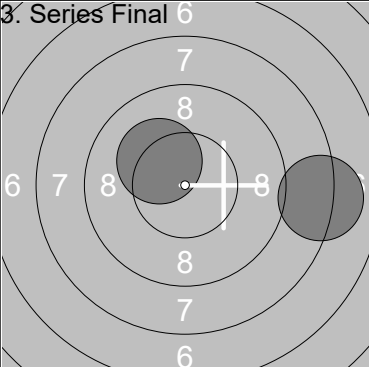
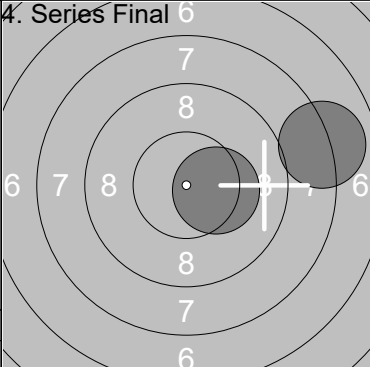
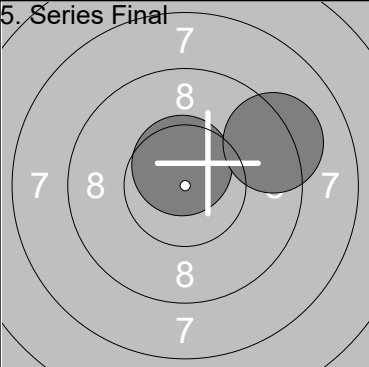
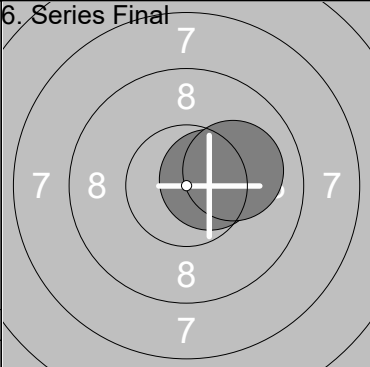
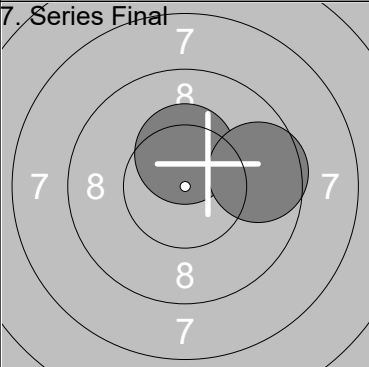
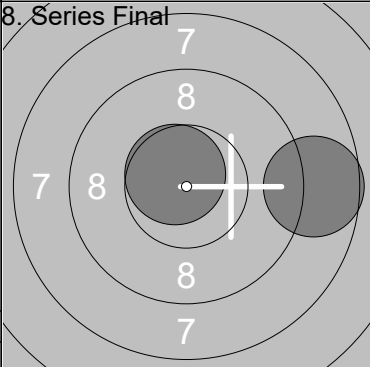
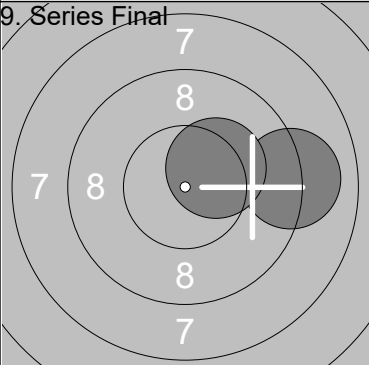
| Relay           | Lane  | BRADBURY Elizabeth   |                          |  |  |
|-----------------|---|--|--------------------------|--|--|
| Wrexham         |   | Rugeley  |                          |  |  |
| 02.04.2017      |   | Rifle Junior   | Welsh Airgun Association |  |  |
| 1. Series Final |    | 1: 10.1 ↗<br>2: 10.7x →<br>3: 9.8 ↗<br>4: 9.4 ←<br>5: 10.0 ↘ | 2. Series Final          |    | 1: 9.9 ↖<br>2: 8.7 ↑<br>3: 10.5x ↑<br>4: 9.7 →<br>5: 8.6 → |
|                 |   | Series 50.0<br>50.0  |                          |  | Series 47.4<br>97.4  |
| 3. Series Final |   | 1: 10.2x ↖<br>2: 8.1 →                                       | 4. Series Final          |   | 1: 10.3x →<br>2: 8.0 →                                     |
|                 |   | Series 18.3<br>115.7   |                          |  | Series 18.3<br>134.0                                       |
| 5. Series Final |  | 1: 10.6x ↑<br>2: 9.2 →                                       | 6. Series Final          |  | 1: 10.5x →<br>2: 10.1 →                                    |
|                 |   | Series 19.8<br>153.8   |                          |  | Series 20.6<br>174.4                                       |
| 7. Series Final |  | 1: 10.4x ↑<br>2: 9.6 →                                       | 8. Series Final          |  | 1: 8.7 →<br>2: 10.7x ↖                                     |
|                 |   | Series 20.0<br>194.4   |                          |  | Series 19.4<br>213.8                                       |
| 9. Series Final |  | 1: 9.1 →<br>2: 10.3x →                                       |                          |  |  |
|                 |   | Series 19.4<br>233.2   |                          |  |  |

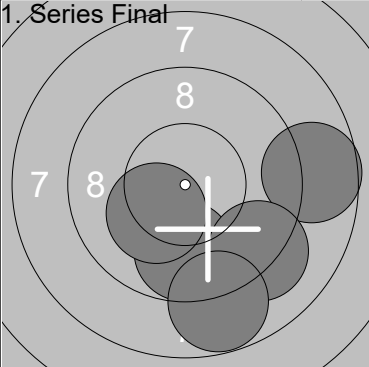
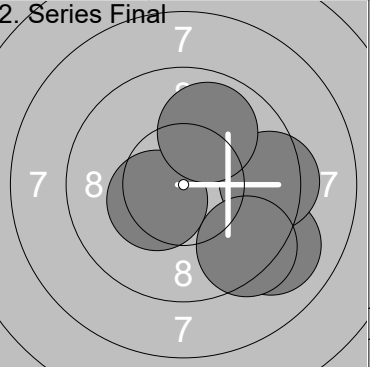
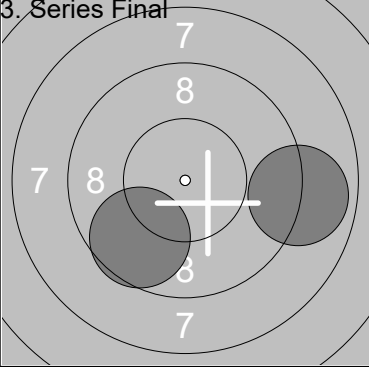
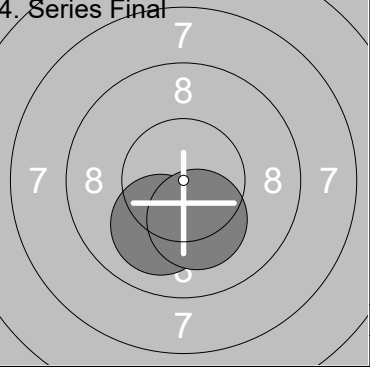
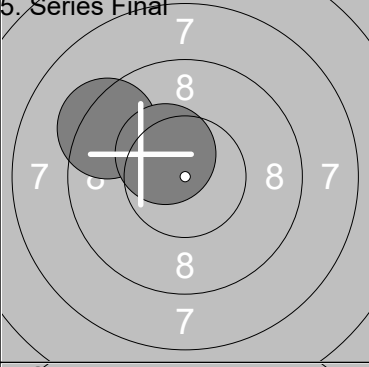
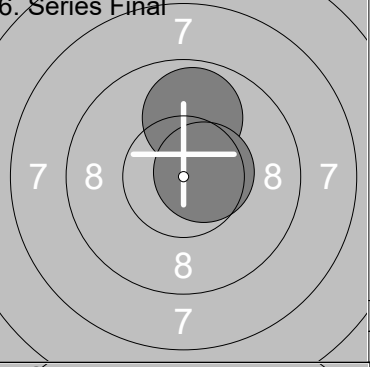
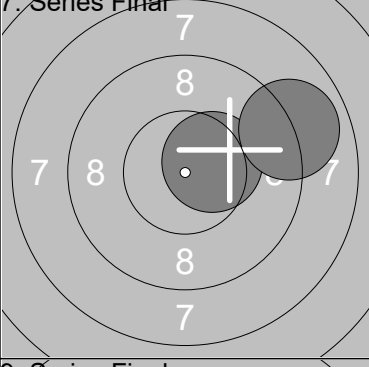
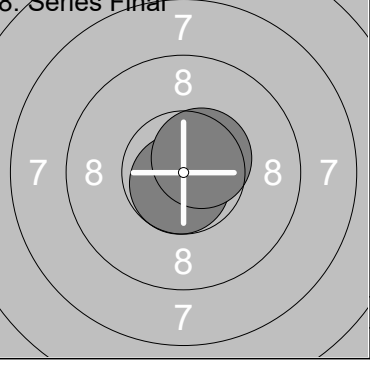
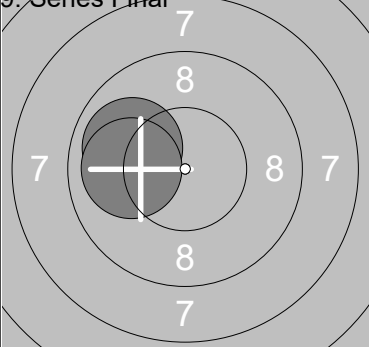
| Relay   | Lane   | MARKLOW David  |  |
|---|--|--|--|
| 1   | 16   |  |  |
| Wrexham   | GEC  |  |  |
| 02.04.2017  | Rifle Junior   | Welsh Airgun Association   |  |
| 1. Series Final   | 1: 9.8 ↓<br>2: 8.7 →<br>3: 10.2x ↙<br>4: 9.2 ↘<br>5: 8.8 ↓ | 2. Series Final  | 1: 9.0 ↘<br>2: 9.4 →<br>3: 10.4x ↙<br>4: 9.9 ↗<br>5: 9.4 ↘ |
|    | Series 46.7<br>46.7  |    | Series 48.1<br>94.8  |
| 3. Series Final   | 1: 9.6 ↘<br>2: 8.9 →                                       | 4. Series Final  | 1: 10.1 ↓<br>2: 10.2x ↓                                    |
|   | Series 18.5<br>113.3                                       |   | Series 20.3<br>133.6                                       |
| 5. Series Final   | 1: 9.3 ↖<br>2: 10.4x ↖                                     | 6. Series Final  | 1: 9.9 ↑<br>2: 10.6x →                                     |
|  | Series 19.7<br>153.3                                       |  | Series 20.5<br>173.8                                       |
| 7. Series Final   | 1: 10.4x →<br>2: 8.9 →                                     | 8. Series Final  | 1: 10.7x ↓<br>2: 10.5x ↗                                   |
|  | Series 19.3<br>193.1                                       |  | Series 21.2<br>214.3                                       |
| 9. Series Final   | 1: 9.9 ←<br>2: 10.0 ←                                      |  |  |
|  | Series 19.9<br>234.2                                       |  |  |

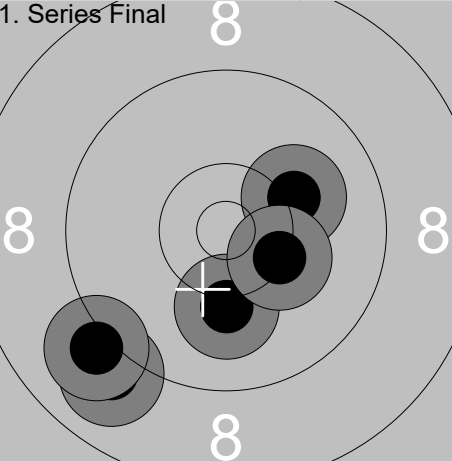
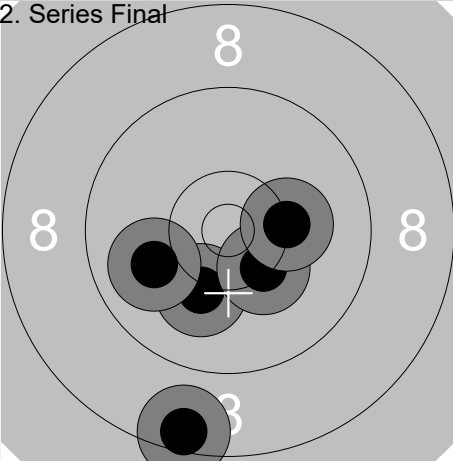
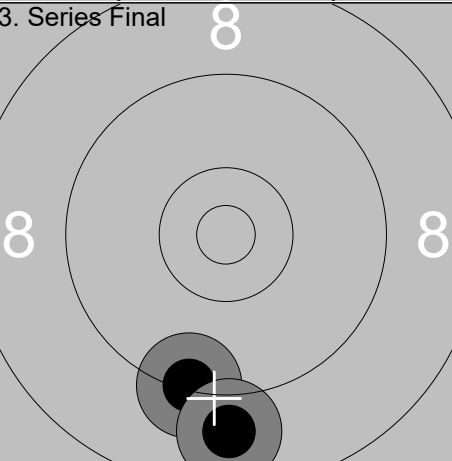
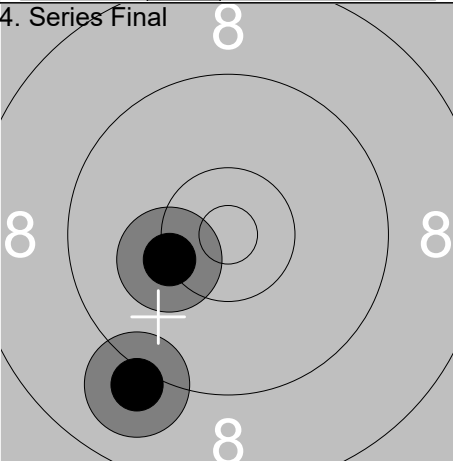
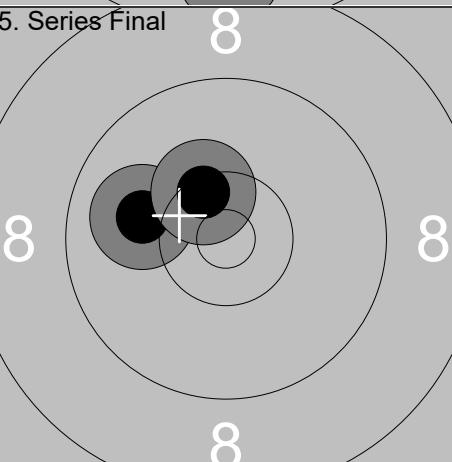
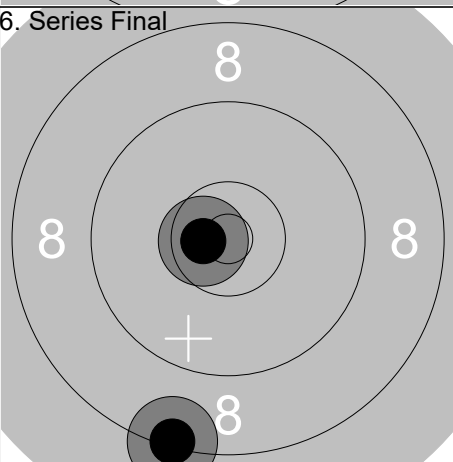
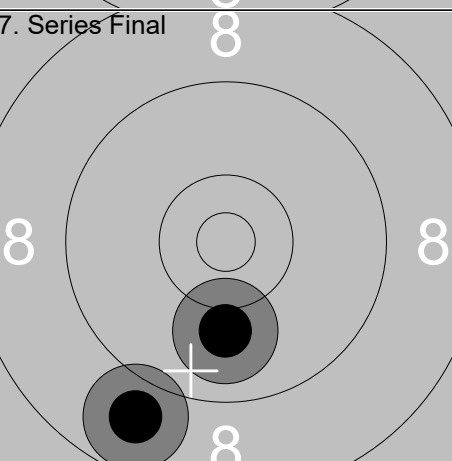
|                   |   |   |   |
|-------------------|---|---|---|
| Relay<br><b>1</b> | Lane<br><b>12</b>   | <b>Ian Jack</b>   |   |
| Wrexham           |   |   |   |
| 02.04.2017        |   | Pistol Senior   | Welsh Airgun Association  |
| 1. Series Final   |    | 1: 10.1 →<br>2: 9.0 ↙<br>3: 9.1 ↙<br>4: 10.1 ↓<br>5: 10.3 → | 2. Series Final<br>   |
|                   |   | Series 48.6   | Series 49.2   |
|                   |   | 48.6  | 97.8  |
| 3. Series Final   |   | 1: 9.3 ↓<br>2: 8.8 ↓  | 4. Series Final<br>  |
|                   |   | Series 18.1   | Series 19.4   |
|                   |   | 115.9   | 135.3   |
| 5. Series Final   |  | 1: 10.0 ←<br>2: 10.4x ↗                                     | 6. Series Final<br> |
|                   |   | Series 20.4   | Series 18.9   |
|                   |   | 155.7   | 174.6   |
| 7. Series Final   |  | 1: 10.0 ↓<br>2: 8.8 ↙                                       |   |
|                   |   | Series 18.8   |   |
|                   |   | 193.4   |   |

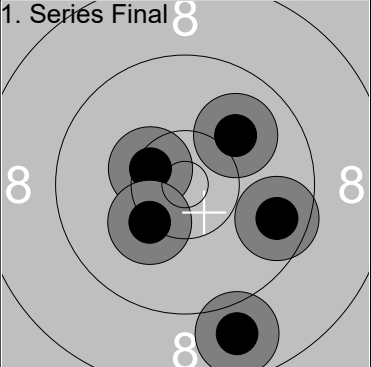
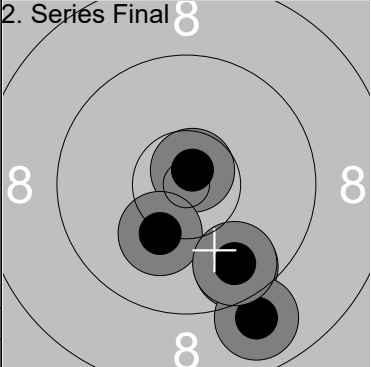
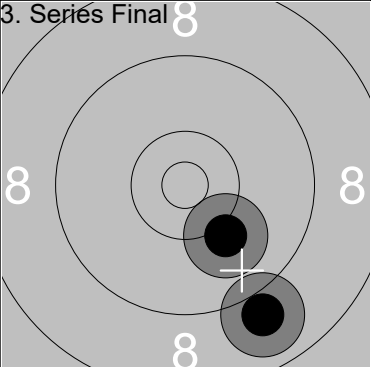
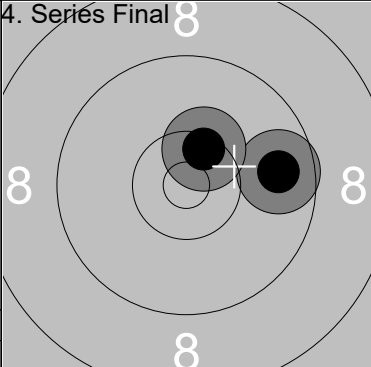
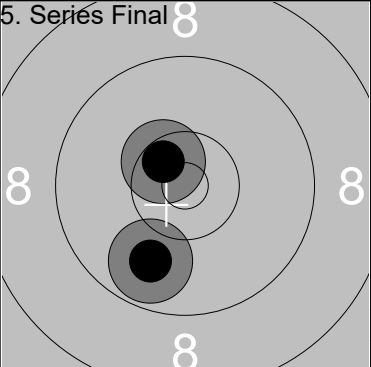
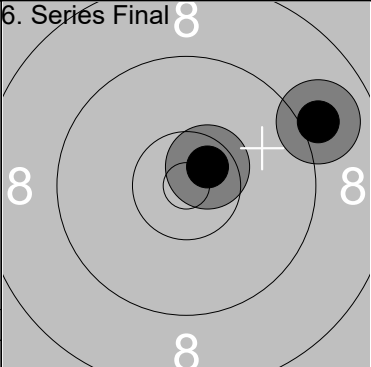
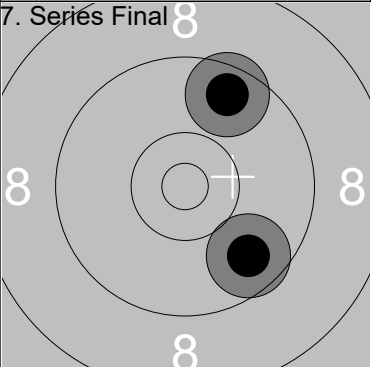
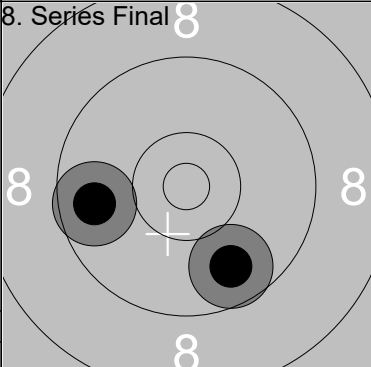
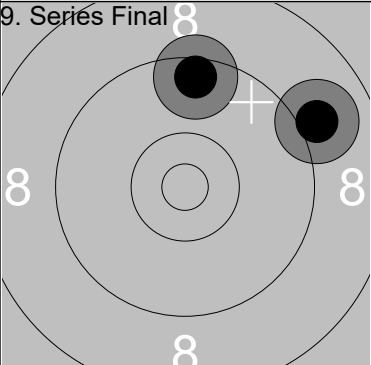

| Relay           | Lane   | Andrew Foster  |                 |
|-----------------|--|--|-----------------|
| Wrexham         |  |  |                 |
| 02.04.2017      | Pistol Senior  | Welsh Airgun Association                                     |                 |
| 1. Series Final |     | 1: 9.6 →<br>2: 8.8 ↓<br>3: 10.4x ↖<br>4: 10.0 ↗<br>5: 10.3 ↓ | 2. Series Final |
|                 |    | 1: 9.7 ↓<br>2: 10.7x ↑<br>3: 8.9 ↓<br>4: 10.2 ↓<br>5: 9.7 ↓  |                 |
|                 | Series 49.1  | Series 49.2  |                 |
|                 | 49.1   | 98.3   |                 |
| 3. Series Final |    | 1: 10.1 ↓<br>2: 8.9 ↓  | 4. Series Final |
|                 |   | 1: 9.7 →<br>2: 10.4x ↑                                       |                 |
|                 | Series 19.0  | Series 20.1  |                 |
|                 | 117.3  | 137.4  |                 |
| 5. Series Final |   | 1: 10.5x ↖<br>2: 9.8 ↓                                       | 6. Series Final |
|                 |  | 1: 10.6x ↗<br>2: 9.0 →                                       |                 |
|                 | Series 20.3  | Series 19.6  |                 |
|                 | 157.7  | 177.3  |                 |
| 7. Series Final |   | 1: 9.6 ↑<br>2: 9.7 ↓   | 8. Series Final |
|                 |  | 1: 9.7 ←<br>2: 9.7 ↓   |                 |
|                 | Series 19.3  | Series 19.4  |                 |
|                 | 196.6  | 216.0  |                 |
| 9. Series Final |   | 1: 9.5 ↑<br>2: 9.0 →   |                 |
|                 | Series 18.5  |  |                 |
|                 | 234.5  |  |                 |

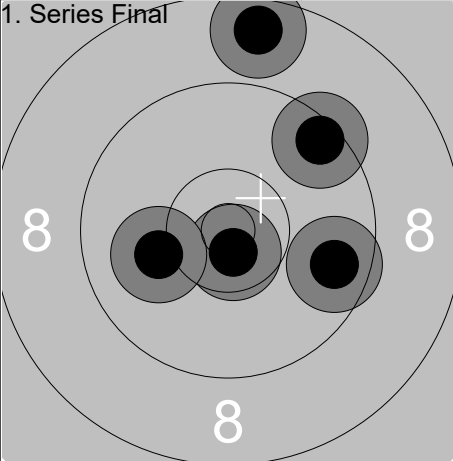
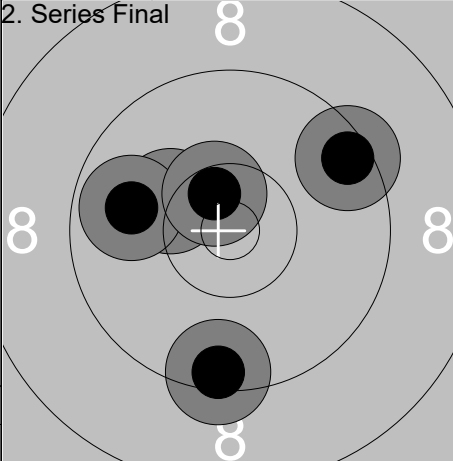
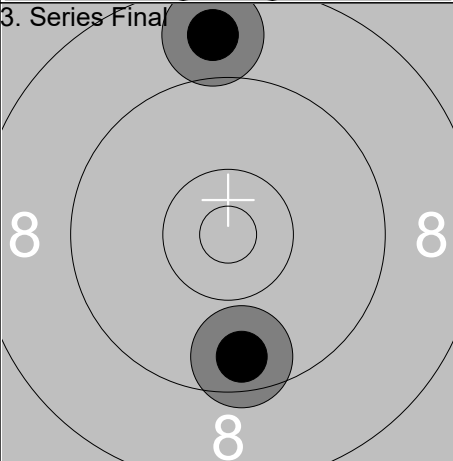
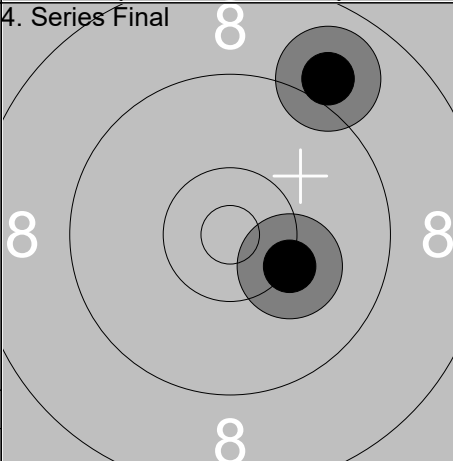
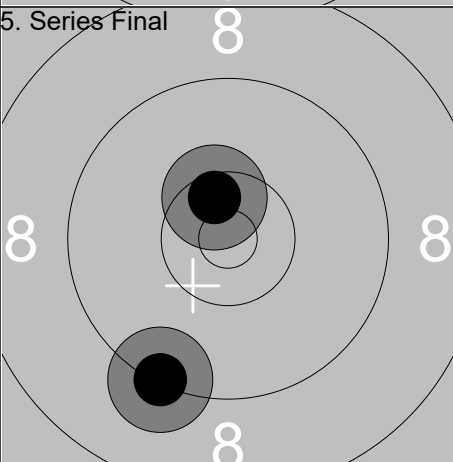
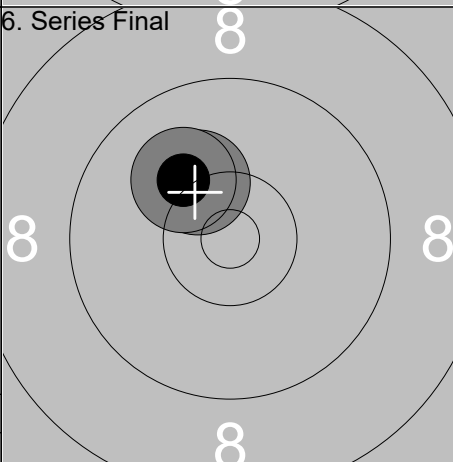
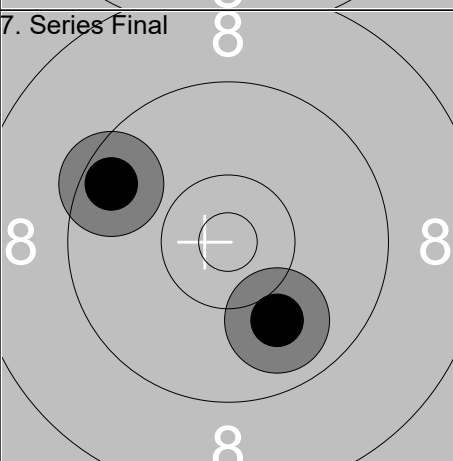
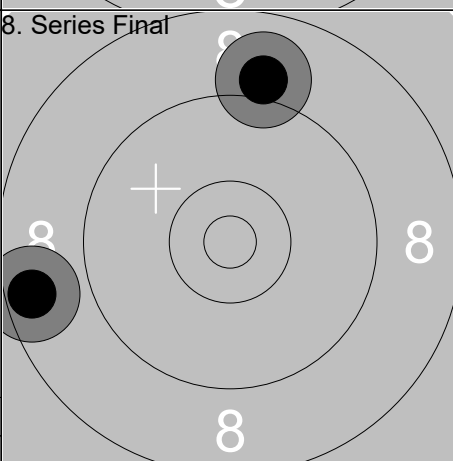
| Relay           | Lane   | Coral Kennerley          |   |
|-----------------|--|--------------------------|---|
| Wrexham         |  |                          |   |
| 02.04.2017      | Pistol Senior  | Welsh Airgun Association |   |
| 1. Series Final |  <p>1: 9.5 ↗<br/>2: 10.7x ↓<br/>3: 10.1 ←<br/>4: 9.7 →<br/>5: 8.6 ↑</p> | 2. Series Final          |  <p>1: 9.4 ↓<br/>2: 10.2 ↖<br/>3: 9.5 ↗<br/>4: 9.9 ←<br/>5: 10.5x ↑</p> |
|                 | Series 48.6  |                          | Series 49.5   |
|                 | 48.6   |                          | 98.1  |
| 3. Series Final |  <p>1: 9.6 ↓<br/>2: 8.8 ↑</p>  | 4. Series Final          |  <p>1: 10.2 →<br/>2: 9.0 ↑</p>   |
|                 | Series 18.4  |                          | Series 19.2   |
|                 | 116.5  |                          | 135.7   |
| 5. Series Final |  <p>1: 9.3 ↓<br/>2: 10.5x ↑</p>                                       | 6. Series Final          |  <p>1: 10.3 ↗<br/>2: 10.1 ↗</p>                                       |
|                 | Series 19.8  |                          | Series 20.4   |
|                 | 155.5  |                          | 175.9   |
| 7. Series Final |  <p>1: 10.0 ↓<br/>2: 9.5 ↖</p>  | 8. Series Final          |  <p>1: 9.0 ↑<br/>2: 8.5 ←</p>   |
|                 | Series 19.5  |                          | Series 17.5   |
|                 | 195.4  |                          | 212.9   |

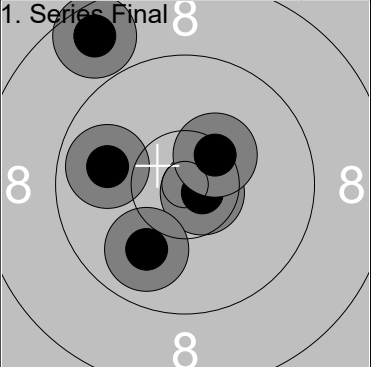
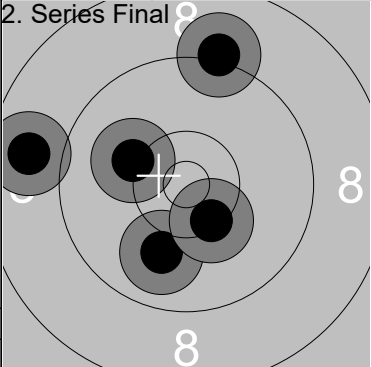
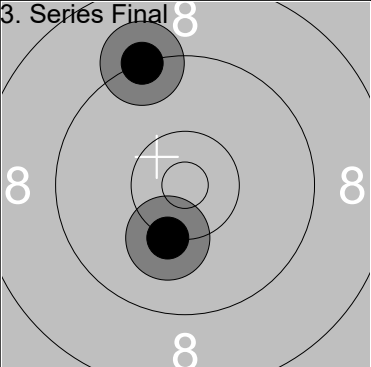
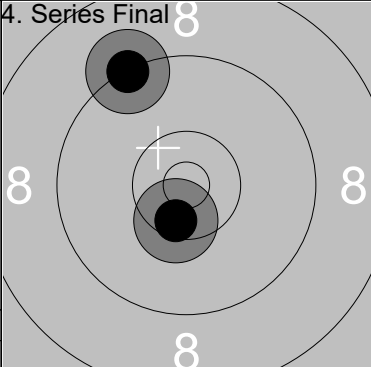
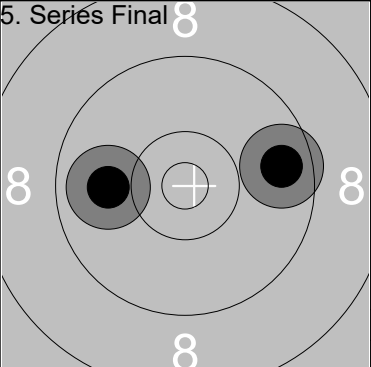
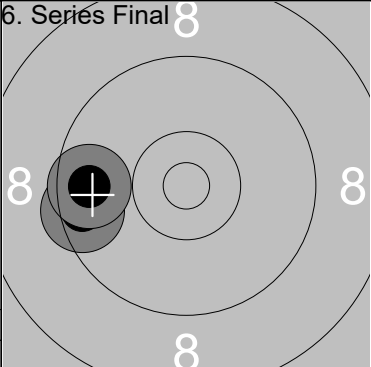
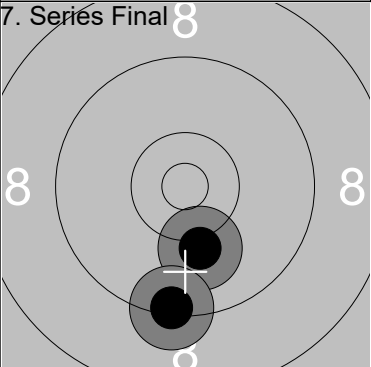
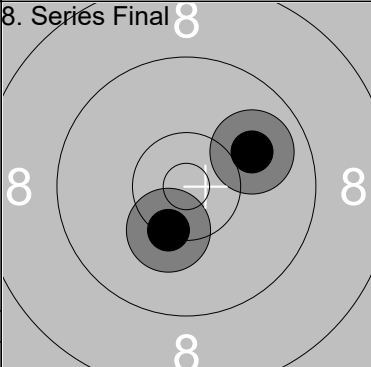
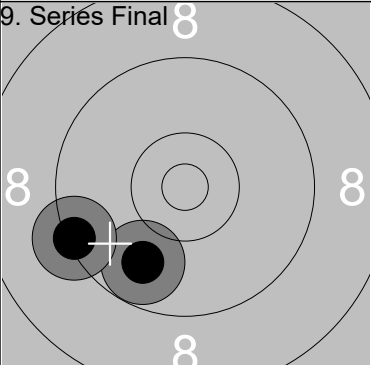
| Relay           | Lane  | Craig Auden              |  |
|-----------------|---|--------------------------|--|
| Wrexham         |   |                          |  |
| 02.04.2017      | Pistol Senior   | Welsh Airgun Association |  |
| 1. Series Final |  <p>1: 10.7x →<br/>2: 10.4x ↗<br/>3: 9.9 ↓<br/>4: 9.9 ←<br/>5: 8.6 ↗</p> <p>Series 49.5<br/>49.5</p> | 2. Series Final          |  <p>1: 10.0 ↓<br/>2: 8.8 ←<br/>3: 9.1 ↑<br/>4: 10.4x ↓<br/>5: 10.2 ↗</p> <p>Series 48.5<br/>98.0</p> |
| 3. Series Final |  <p>1: 9.2 ↑<br/>2: 10.2 ↓</p> <p>Series 19.4<br/>117.4</p>   | 4. Series Final          |  <p>1: 10.5x ↓<br/>2: 9.3 ↗</p> <p>Series 19.8<br/>137.2</p>  |
| 5. Series Final |  <p>1: 9.9 ←<br/>2: 9.6 →</p> <p>Series 19.5<br/>156.7</p>   | 6. Series Final          |  <p>1: 9.5 ←<br/>2: 9.7 ←</p> <p>Series 19.2<br/>175.9</p>   |
| 7. Series Final |  <p>1: 10.1 ↓<br/>2: 9.3 ↓</p> <p>Series 19.4<br/>195.3</p>  | 8. Series Final          |  <p>1: 10.3 ↓<br/>2: 10.0 ↗</p> <p>Series 20.3<br/>215.6</p>                                       |
| 9. Series Final |  <p>1: 9.8 ↓<br/>2: 9.3 ←</p> <p>Series 19.1<br/>234.7</p>   |                          |  |

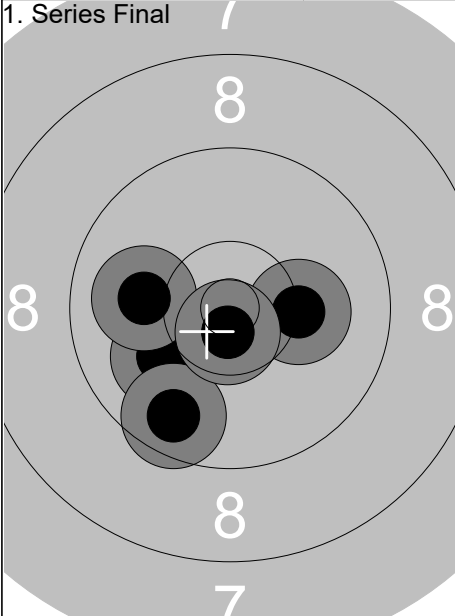
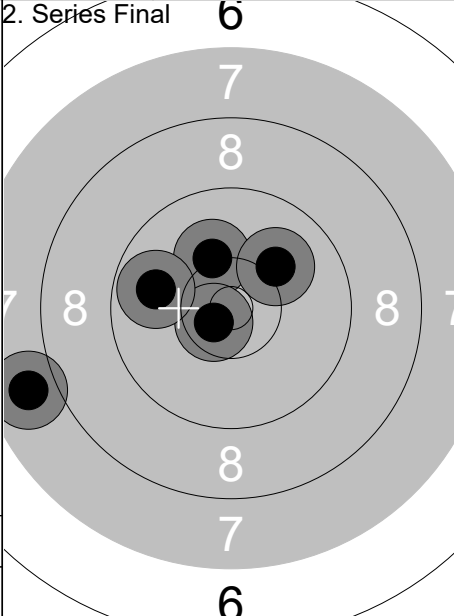
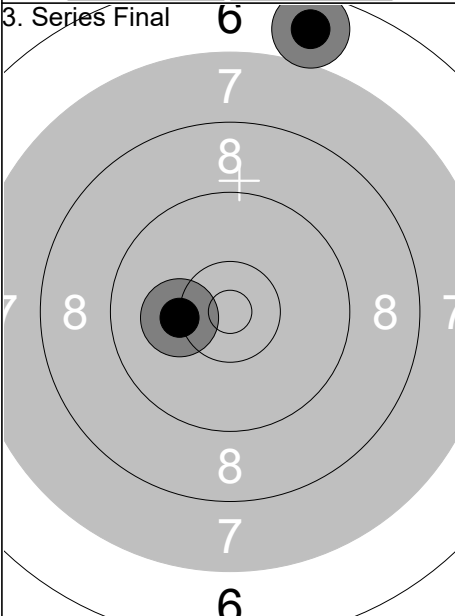
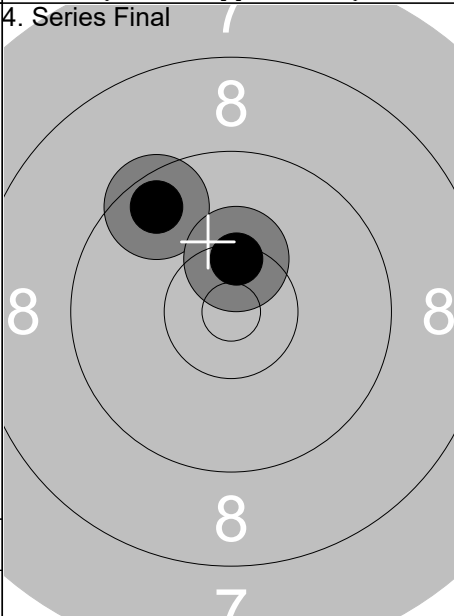
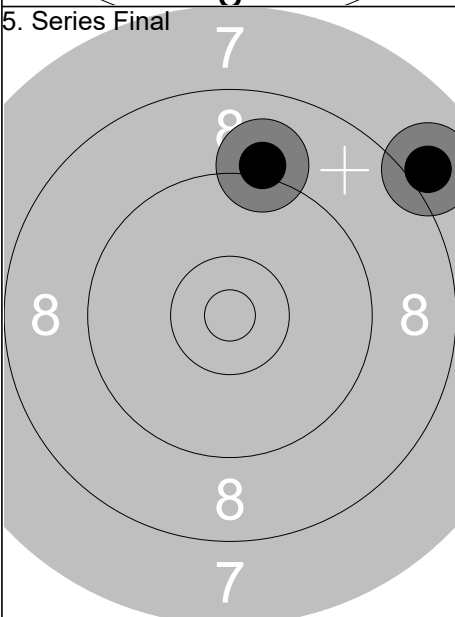
|                   |   |   |   |
|-------------------|---|---|---|
| Relay<br><b>1</b> | Lane<br><b>17</b>   | <b>Alan Goodall</b>   |   |
| Wrexham           |   |   |   |
| 02.04.2017        |   | Pistol Senior   | Welsh Airgun Association  |
| 1. Series Final   |    | 1: 10.2 →<br>2: 10.1 ↙<br>3: 10.0 ←<br>4: 9.6 ↓<br>5: 10.7x ↓ | 2. Series Final   |
|                   | Series 50.6   |   |   |
|                   | 50.6  |   | Series 48.5   |
|                   |   |   | 99.1  |
| 3. Series Final   |   | 1: 10.2 ←<br>2: 6.7 ↑   | 4. Series Final   |
|                   | Series 16.9   |   |  |
|                   | 116.0   |   | Series 20.0   |
|                   |   |   | 136.0   |
| 5. Series Final   |  | 1: 8.0 ↗<br>2: 9.1 ↑  |   |
|                   | Series 17.1   |   |   |
|                   | 153.1   |   |   |

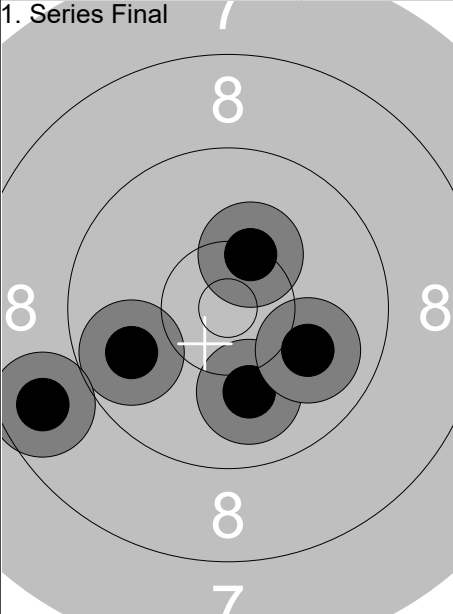
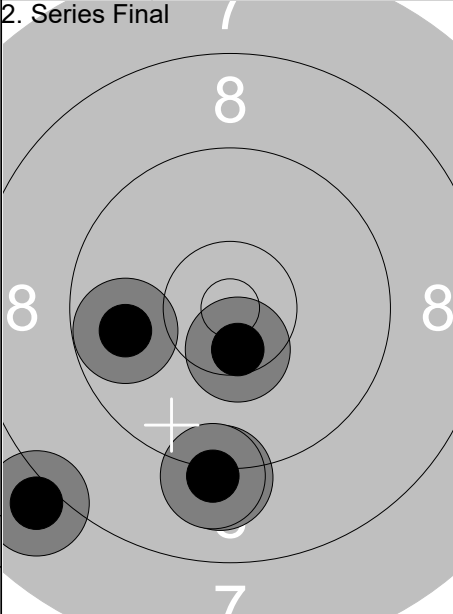
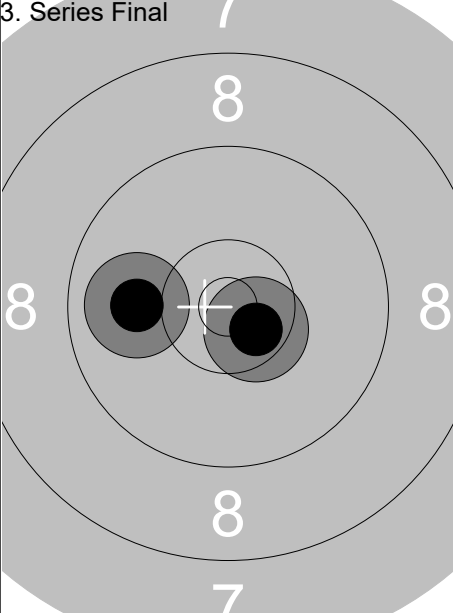
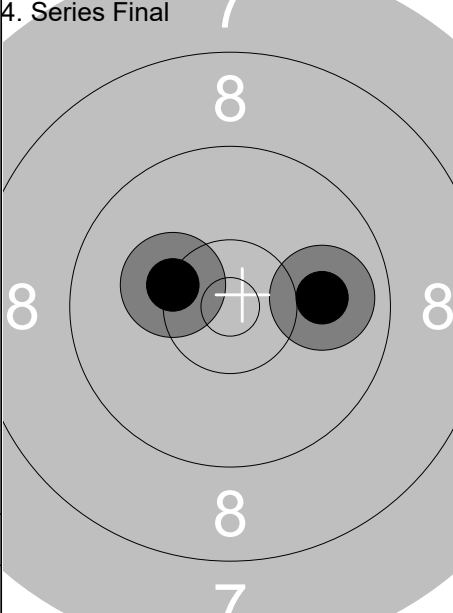
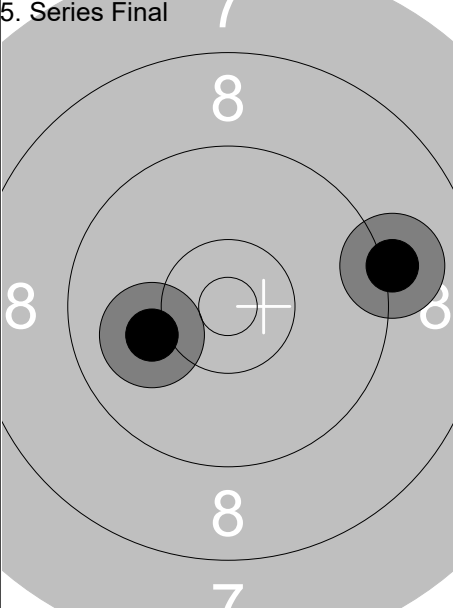
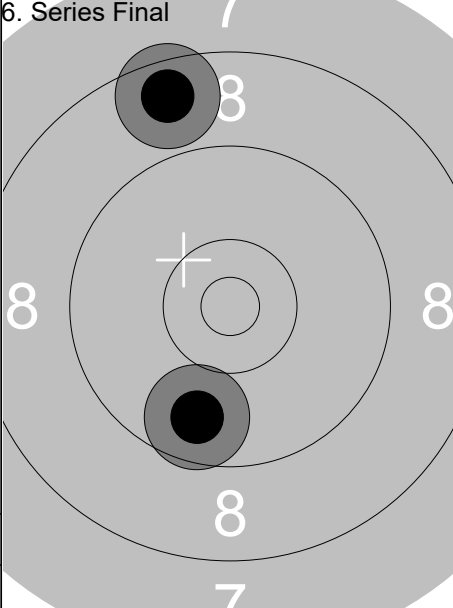
| Relay           | Lane  | Alan Green  |  |
|-----------------|---|---|--|
| Wrexham         |   |   |  |
| 02.04.2017      | Pistol Senior   | Welsh Airgun Association                                    |  |
| 1. Series Final |    | 1: 10.0 ↓<br>2: 9.8 ←<br>3: 10.3 ↑<br>4: 8.7 ←<br>5: 10.0 ↘ | 2. Series Final  |
|                 |   | Series 48.8   |    |
|                 |   | 48.8  | Series 46.5  |
|                 |   |   | 95.3   |
| 3. Series Final |   | 1: 10.0 ←<br>2: 10.6x ↘                                     | 4. Series Final  |
|                 |   | Series 20.6   |   |
|                 |   | 115.9   | Series 20.3  |
|                 |   |   | 136.2  |
| 5. Series Final |  | 1: 9.1 →<br>2: 10.1 ←                                       | 6. Series Final  |
|                 |   | Series 19.2   |  |
|                 |   | 155.4   | Series 18.3  |
|                 |   |   | 173.7  |

|                   |                   |                          |
|-------------------|-------------------|--------------------------|
| Relay<br><b>1</b> | Lane<br><b>19</b> | <b>Waldek Mickiewicz</b> |
|-------------------|-------------------|--------------------------|

|         |  |  |
|---------|--|--|
| Wrexham |  |  |
|---------|--|--|

|            |               |                          |
|------------|---------------|--------------------------|
| 02.04.2017 | Pistol Senior | Welsh Airgun Association |
|------------|---------------|--------------------------|

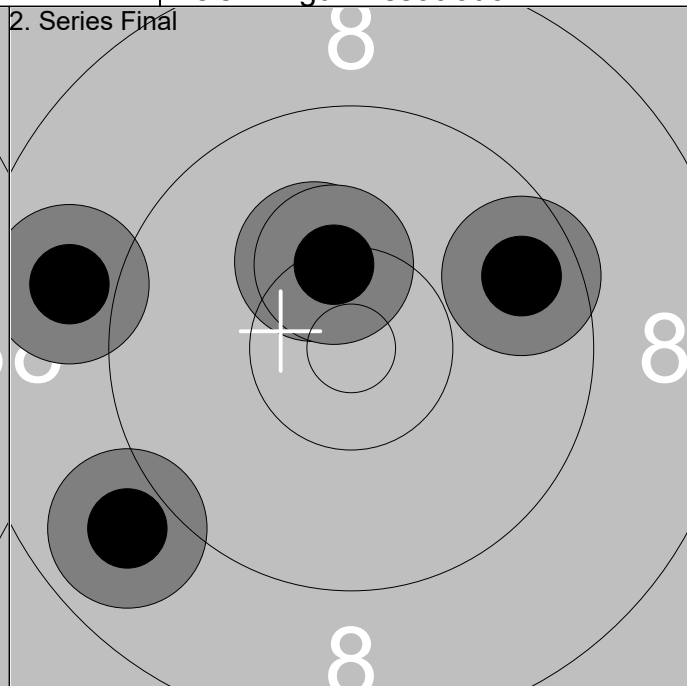
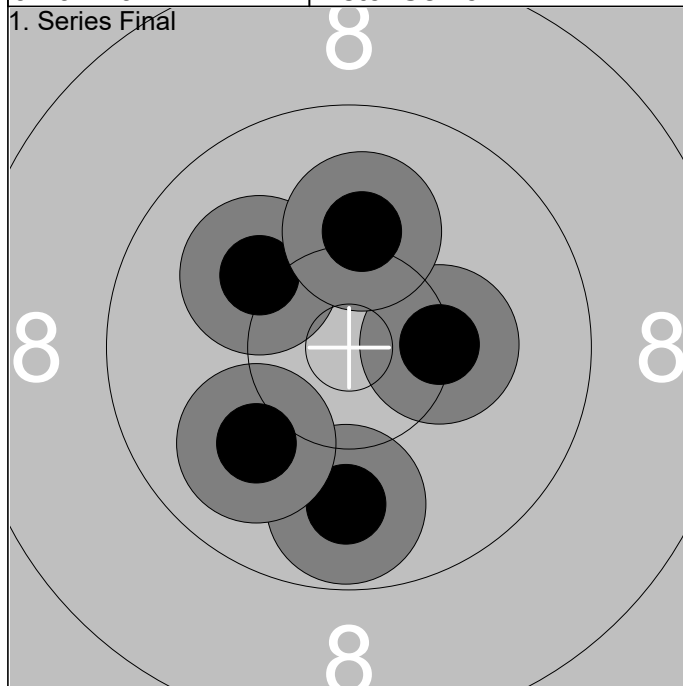

|           |        |      |
|-----------|--------|------|
| 1: 9.8 ↓  | Series | 50.3 |
| 2: 10.1 ↖ |        |      |
| 3: 10.0 ↙ |        |      |
| 4: 10.3 → |        |      |
| 5: 10.1 ↑ |        |      |

|           |        |      |
|-----------|--------|------|
| 1: 9.6 →  | Series | 48.0 |
| 2: 8.9 ↙  |        |      |
| 3: 10.3 ↑ |        |      |
| 4: 8.9 ←  |        |      |
| 5: 10.3 ↑ |        |      |

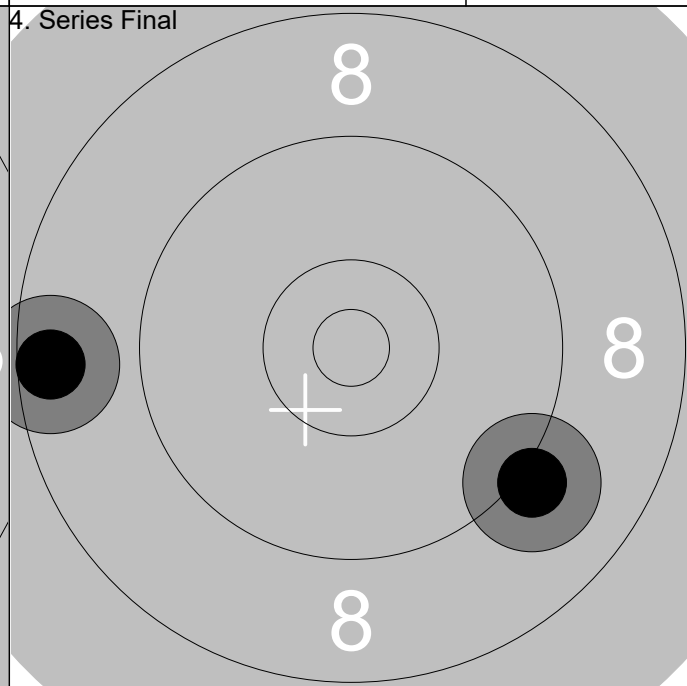
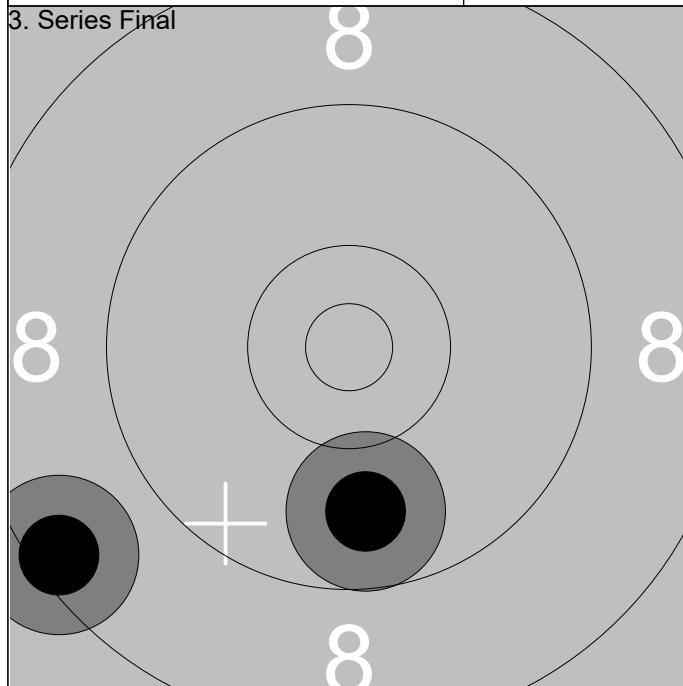

|          |        |       |
|----------|--------|-------|
| 1: 8.4 ↙ | Series | 18.2  |
| 2: 9.8 ↓ |        |       |
|          |        | 116.5 |

|          |        |       |
|----------|--------|-------|
| 1: 9.1 ↘ | Series | 17.6  |
| 2: 8.5 ← |        |       |
|          |        | 134.1 |

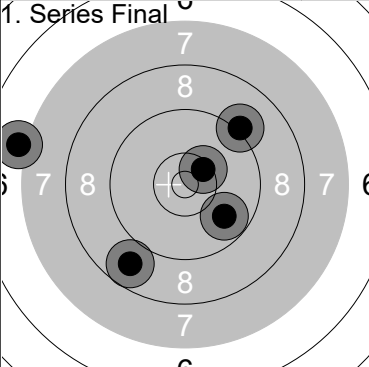
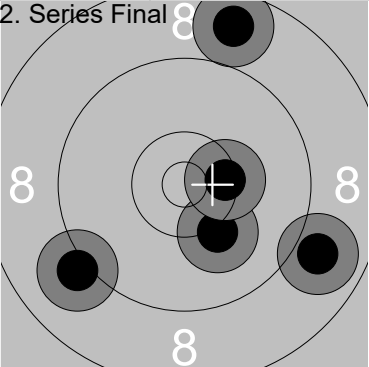
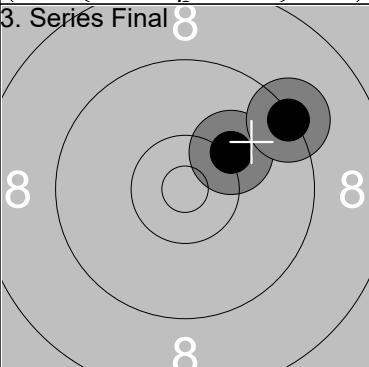
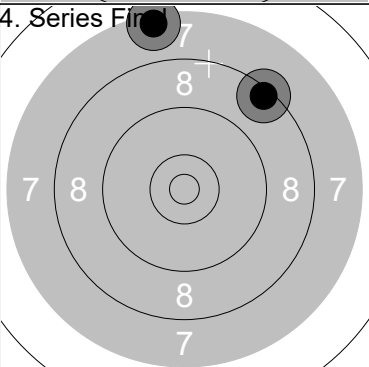
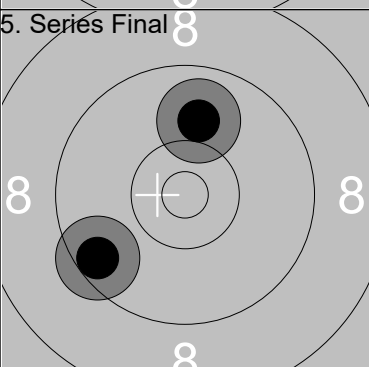
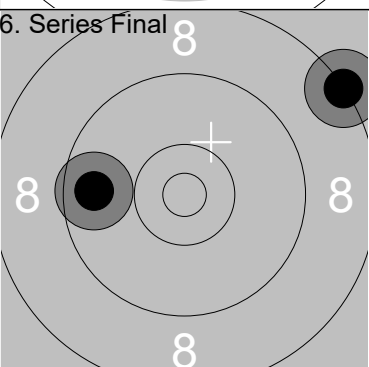
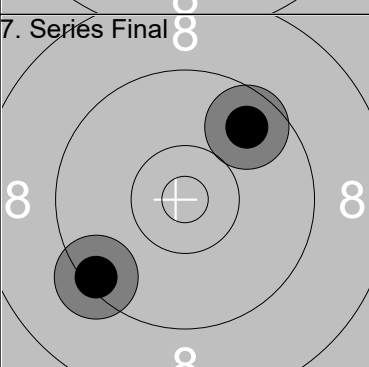
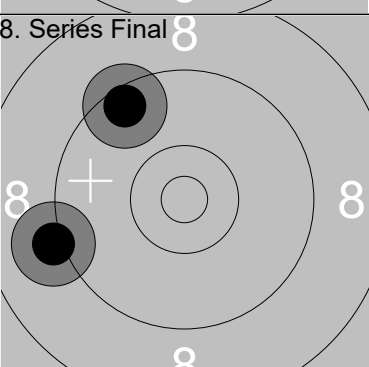
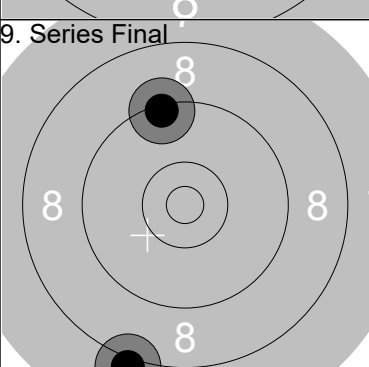
| Relay           | Lane  | Kari Dougall   |   |   |
|-----------------|---|--|---|---|
| Wrexham         |   |  |   |   |
| 02.04.2017      |   | Pistol Junior  | Welsh Airgun Association  |   |
| 1. Series Final |    | 1: 10.4x ↗<br>2: 9.8 ↘<br>3: 7.1 ←<br>4: 9.2 ↗<br>5: 8.8 ↘ | 2. Series Final<br>   | 1: 8.9 ↘<br>2: 9.1 ↙<br>3: 8.7 ↑<br>4: 10.2 ↘<br>5: 10.4x → |
|                 |   | Series 45.3  | Series 47.3   |   |
|                 |   | 45.3   | 92.6  |   |
| 3. Series Final |   | 1: 10.2 ↗<br>2: 9.3 ↗                                      | 4. Series Final<br>  | 1: 8.4 ↗<br>2: 7.4 ↑  |
|                 |   | Series 19.5  | Series 15.8   |   |
|                 |   | 112.1  | 127.9   |   |
| 5. Series Final |  | 1: 9.5 ↙<br>2: 9.9 ↑                                       | 6. Series Final<br> | 1: 8.2 ↗<br>2: 9.7 ←  |
|                 |   | Series 19.4  | Series 17.9   |   |
|                 |   | 147.3  | 165.2   |   |
| 7. Series Final |  | 1: 9.7 ↗<br>2: 9.4 ↙                                       | 8. Series Final<br> | 1: 9.5 ↘<br>2: 9.1 ←  |
|                 |   | Series 19.1  | Series 18.6   |   |
|                 |   | 184.3  | 202.9   |   |
| 9. Series Final |  | 1: 9.3 ↑<br>2: 8.1 ↘                                       |   |   |
|                 |   | Series 17.4  |   |   |
|                 |   | 220.3  |   |   |

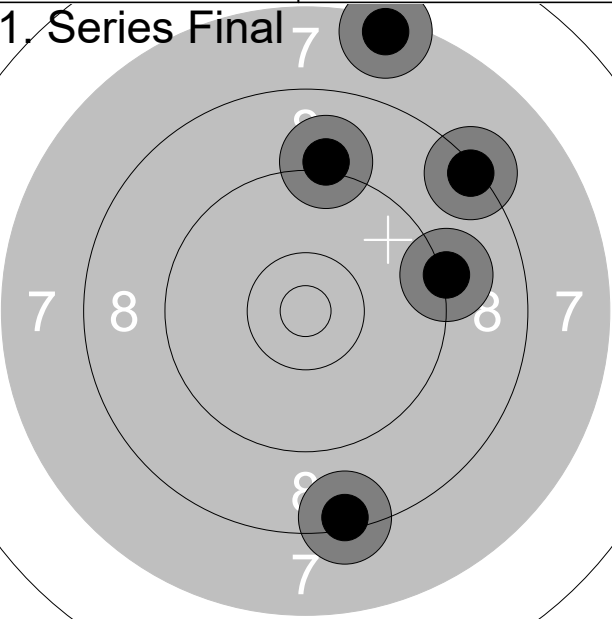
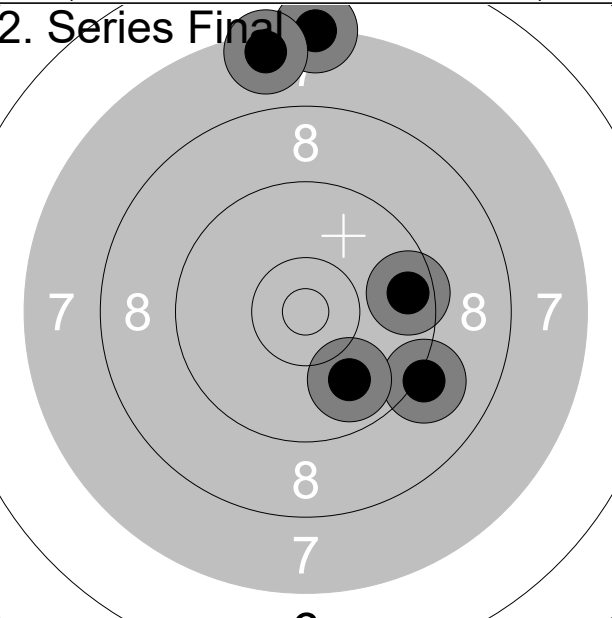
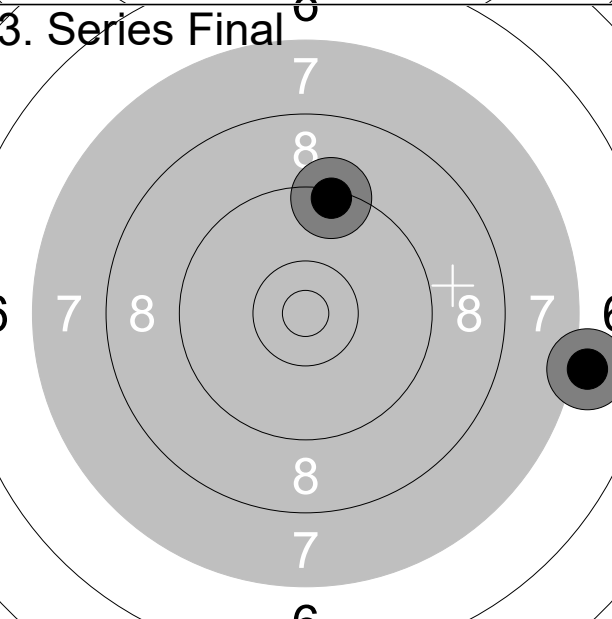
| Relay           | Lane  | Hannah Glover            |  |       |
|-----------------|---|--------------------------|--|-------|
| Wrexham         |   |                          |  |       |
| 02.04.2017      | Pistol Junior   | Welsh Airgun Association |  |       |
| 1. Series Final |    | 1: 8.4                   |  | ↓     |
|                 |   | 2: 9.2                   |  | →     |
|                 |   | 3: 9.1                   |  | ↑     |
|                 |   | 4: 8.3                   |  | ↗     |
|                 |   | 5: 7.4                   |  | ↑     |
|                 | Series  |                          |  | 42.4  |
|                 |   |                          |  | 42.4  |
| 2. Series Final |   | 1: 7.2                   |  | ↑     |
|                 |   | 2: 7.5                   |  | ↑     |
|                 |   | 3: 9.1                   |  | ↘     |
|                 |   | 4: 9.6                   |  | →     |
|                 |   | 5: 9.9                   |  | ↘     |
|                 | Series  |                          |  | 43.3  |
|                 |   |                          |  | 85.7  |
| 3. Series Final |  | 1: 9.3                   |  | ↑     |
|                 |   | 2: 7.0                   |  | →     |
|                 | Series  |                          |  | 16.3  |
|                 |   |                          |  | 102.0 |

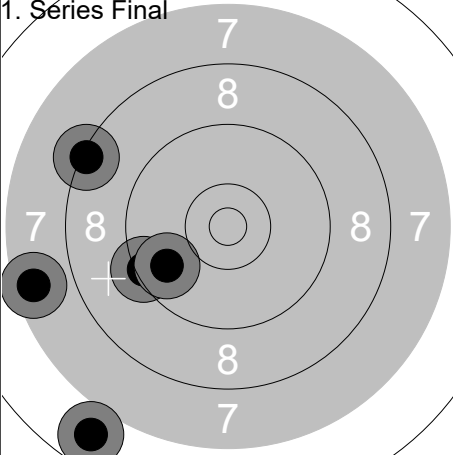
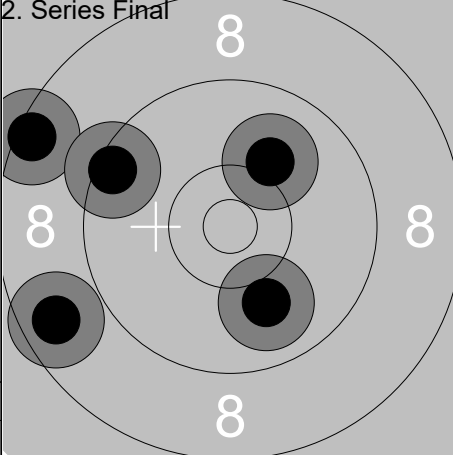
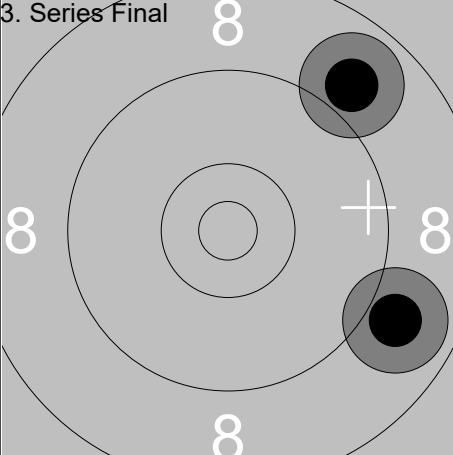
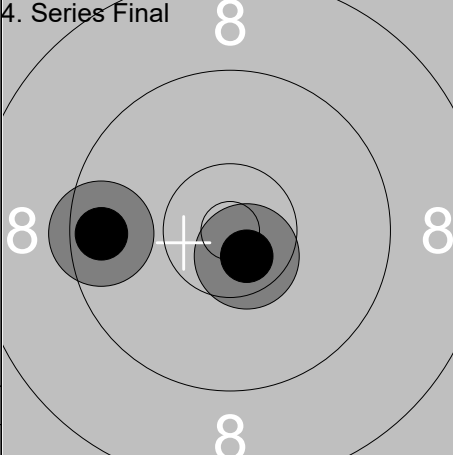
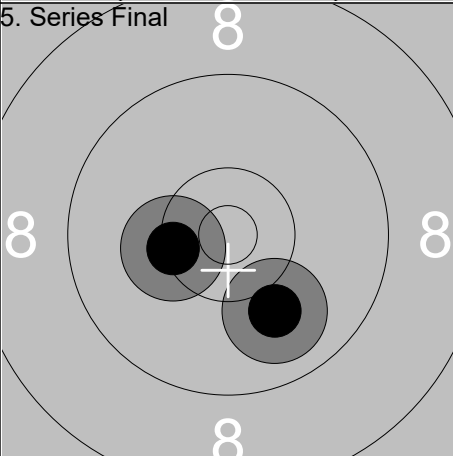
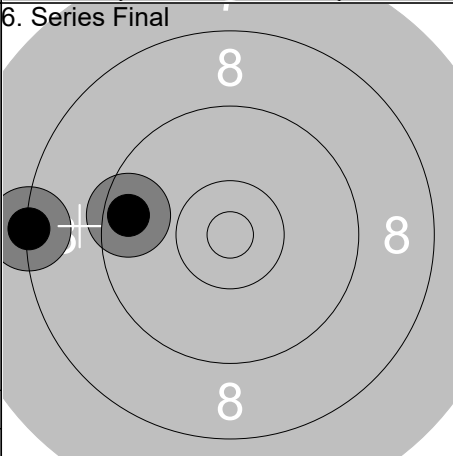
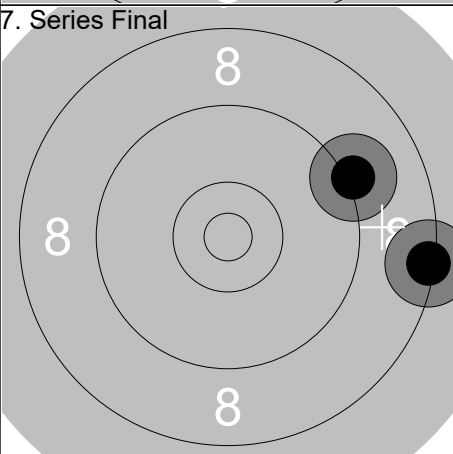

|                   |                   |   |  |
|-------------------|-------------------|---|--|
| Relay<br><b>1</b> | Lane<br><b>14</b> | <b>Lucy Thomas</b>  |  |
| Wrexham           |                   |   |  |
| 02.04.2017        |                   | Pistol Junior   | Welsh Airgun Association   |
| 1. Series Final   |                   |  <p>1: 6.8 ↙<br/>2: 8.3 ↖<br/>3: 9.4 ↖<br/>4: 9.7 ↖<br/>5: 7.5 ↖</p> <p>Series 41.7<br/>41.7</p> | 2. Series Final  <p>1: 10.0 ↘<br/>2: 8.4 ↖<br/>3: 10.1 ↗<br/>4: 9.4 ↖<br/>5: 8.6 ↖</p> <p>Series 46.5<br/>88.2</p> |
| 3. Series Final   |                   |  <p>1: 8.9 ↘<br/>2: 8.9 ↗</p> <p>Series 17.8<br/>106.0</p>                                      | 4. Series Final  <p>1: 9.6 ↖<br/>2: 10.6x ↘</p> <p>Series 20.2<br/>126.2</p>                                      |
| 5. Series Final   |                   |  <p>1: 10.0 ↘<br/>2: 10.3 ↖</p> <p>Series 20.3<br/>146.5</p>                                   | 6. Series Final  <p>1: 8.3 ↖<br/>2: 9.6 ↖</p> <p>Series 17.9<br/>164.4</p>                                       |
| 7. Series Final   |                   |  <p>1: 8.3 →<br/>2: 9.1 →</p> <p>Series 17.4<br/>181.8</p>                                     |  |

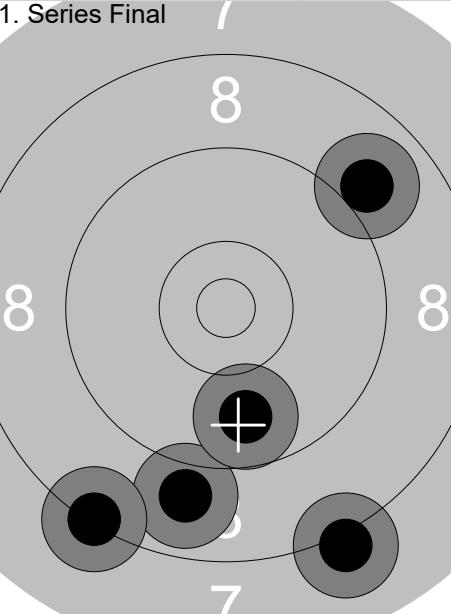
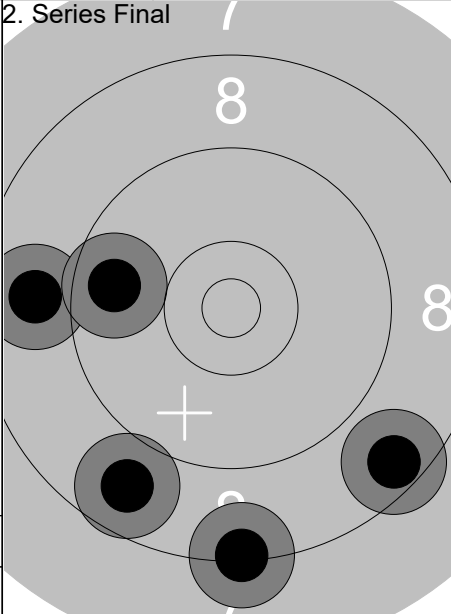
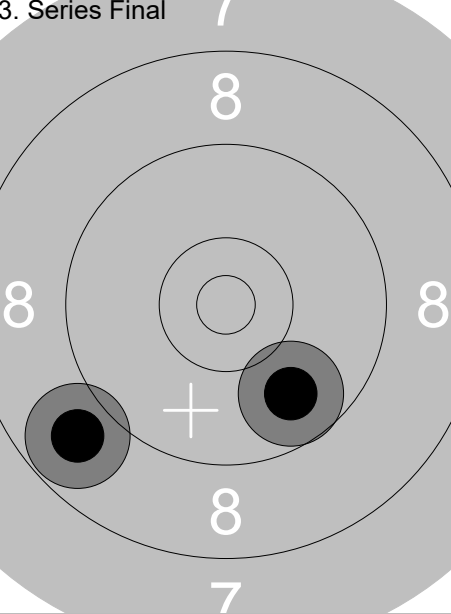
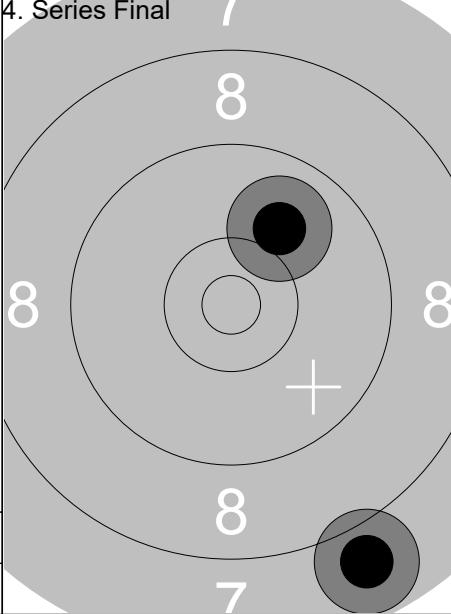
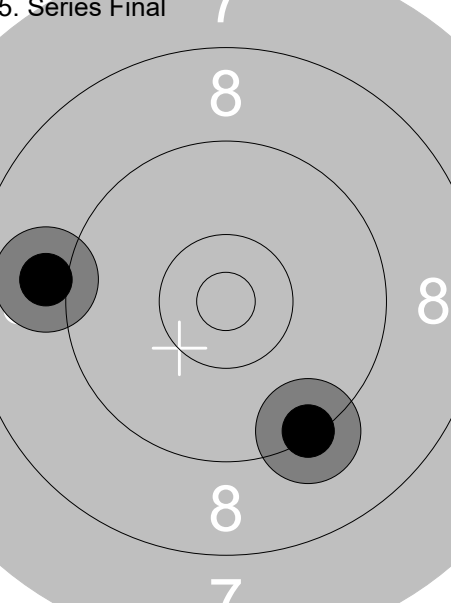
|                   |   |  |  |
|-------------------|---|--|--|
| Relay<br><b>1</b> | Lane<br><b>15</b>   | <b>Megan Horbury</b>                                     |  |
| Wrexham           |   |  |  |
| 02.04.2017        |   | Pistol Junior  | Welsh Airgun Association   |
| 1. Series Final   |    | 1: 8.9 ↓<br>2: 9.0 ↗<br>3: 8.3 ↓<br>4: 8.1 ↓<br>5: 9.8 ↓ | 2. Series Final<br> 1: 8.8 ←<br>2: 8.3 ↓<br>3: 8.5 ↓<br>4: 9.7 ←<br>5: 8.7 ↓ |
|                   |   | Series 44.1  | Series 44.0  |
|                   |   | 44.1   | 88.1   |
| 3. Series Final   |   | 1: 9.8 ↓<br>2: 8.8 ↙                                     | 4. Series Final<br> 1: 7.8 ↓<br>2: 10.0 ↗                                   |
|                   |   | Series 18.6  | Series 17.8  |
|                   |   | 106.7  | 124.5  |
| 5. Series Final   |  | 1: 9.0 ←<br>2: 9.3 ↓                                     |  |
|                   |   | Series 18.3  |  |
|                   |   | 142.8  |  |

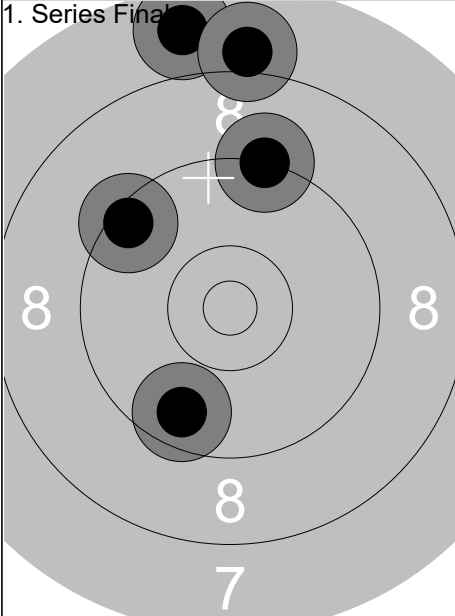
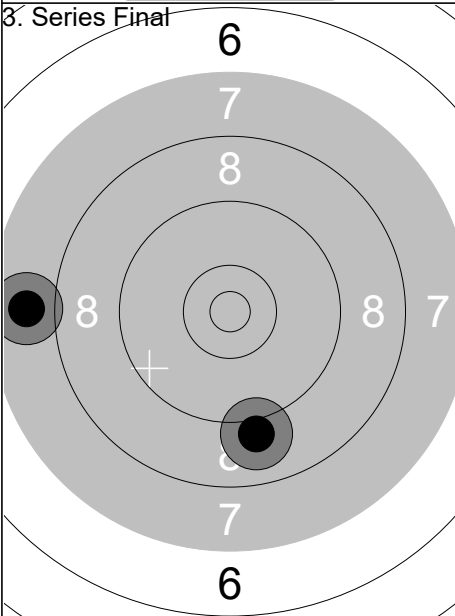
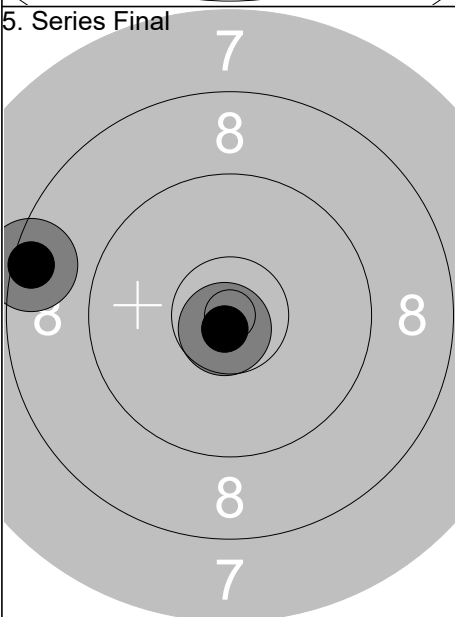
|                   |   |  |   |
|-------------------|---|--|---|
| Relay<br><b>1</b> | Lane<br><b>16</b>   | <b>Steffan Herdman</b>                                   |   |
| Wrexham           |   |  |   |
| 02.04.2017        |   | Pistol Junior  | Welsh Airgun Association                                  |
| 1. Series Final   |    | 1: 9.4 ↖<br>2: 9.6 ↘<br>3: 7.7 ↑<br>4: 9.2 ↑<br>5: 8.0 ↑ | 2. Series Final   |
|                   |   | Series 43.9  | 1: 9.0 ↘<br>2: 8.8 →<br>3: 10.1 ↖<br>4: 9.2 ↘<br>5: 8.3 ← |
|                   |   | 43.9   | Series 45.4   |
|                   |   |  | 89.3  |
| 3. Series Final   |   | 1: 9.0 ↓<br>2: 7.8 ←                                     | 4. Series Final   |
|                   |   | Series 16.8  | 1: 9.9 ↑<br>2: 8.7 ←                                      |
|                   |   | 106.1  | Series 18.6   |
|                   |   |  | 124.7   |
| 5. Series Final   |  | 1: 8.5 ←<br>2: 10.8x ↘                                   | 6. Series Final   |
|                   |   | Series 19.3  | 1: 10.3 →<br>2: 8.9 ↑                                     |
|                   |   | 144.0  | Series 19.2   |
|                   |   |  | 163.2   |

|          |           |                      |
|----------|-----------|----------------------|
| Relay    | Lane      | <b>Rachael Joyce</b> |
| <b>1</b> | <b>17</b> |                      |

|         |  |  |  |
|---------|--|--|--|
| Wrexham |  |  |  |
|---------|--|--|--|

|            |               |                          |  |
|------------|---------------|--------------------------|--|
| 02.04.2017 | Pistol Junior | Welsh Airgun Association |  |
|------------|---------------|--------------------------|--|

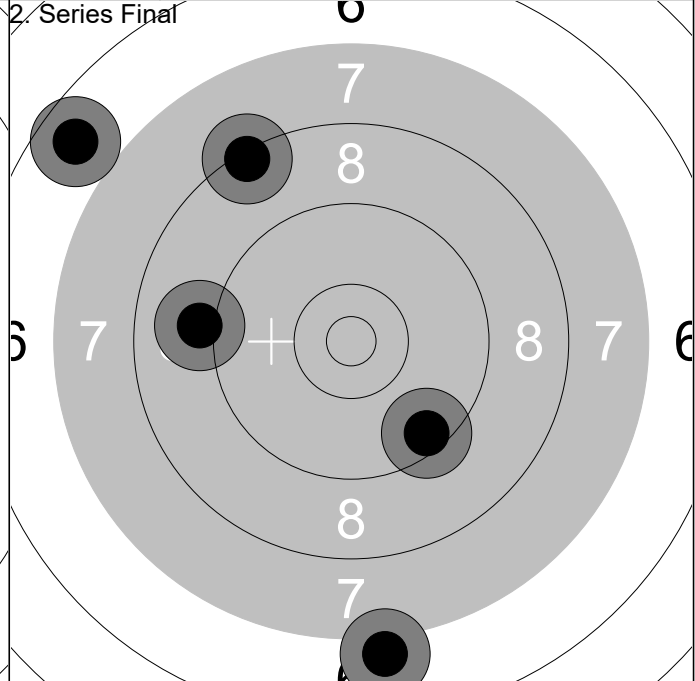
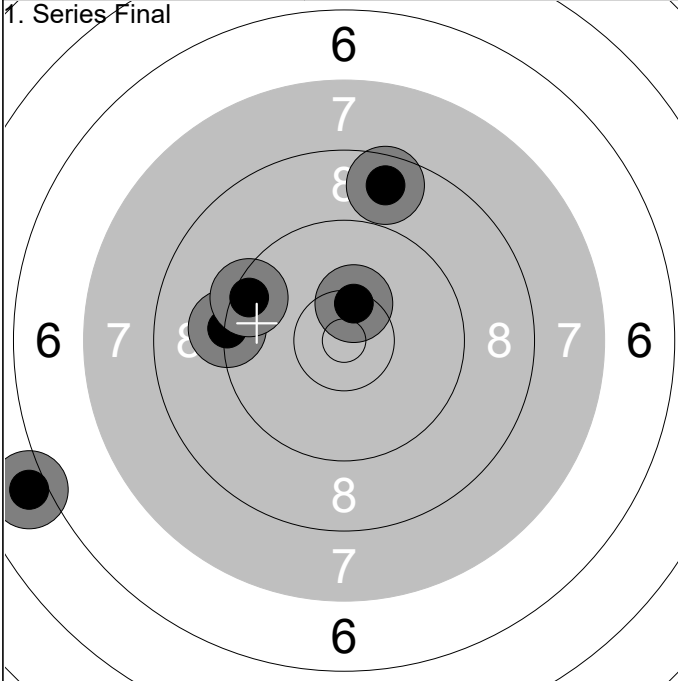

|          |   |
|----------|---|
| 1: 9.3   | ← |
| 2: 9.5   | ↖ |
| 3: 8.7   | ↑ |
| 4: 10.4x | ↑ |
| 5: 6.0   | ← |

|        |      |
|--------|------|
| Series | 43.9 |
|        | 43.9 |

|        |   |
|--------|---|
| 1: 6.7 | ↗ |
| 2: 8.3 | ↗ |
| 3: 9.1 | ← |
| 4: 7.0 | ↓ |
| 5: 9.5 | ↘ |

|        |      |
|--------|------|
| Series | 40.6 |
|        | 84.5 |

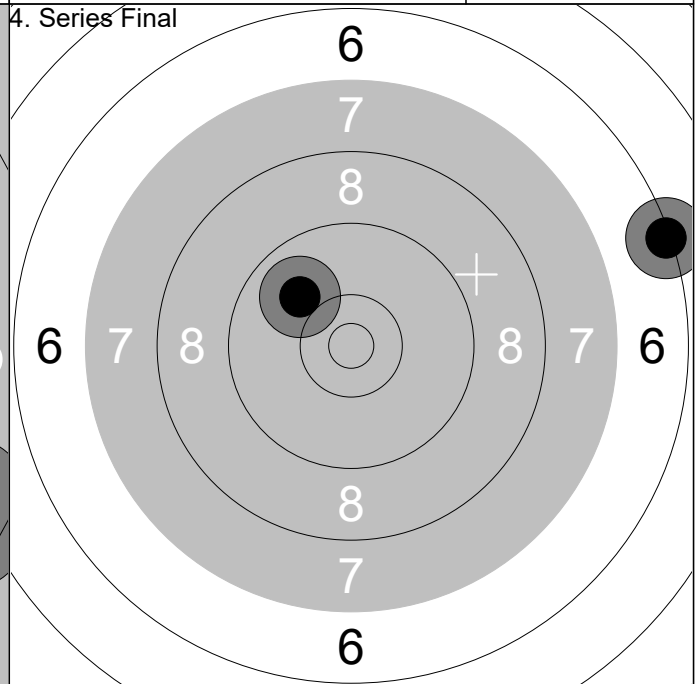
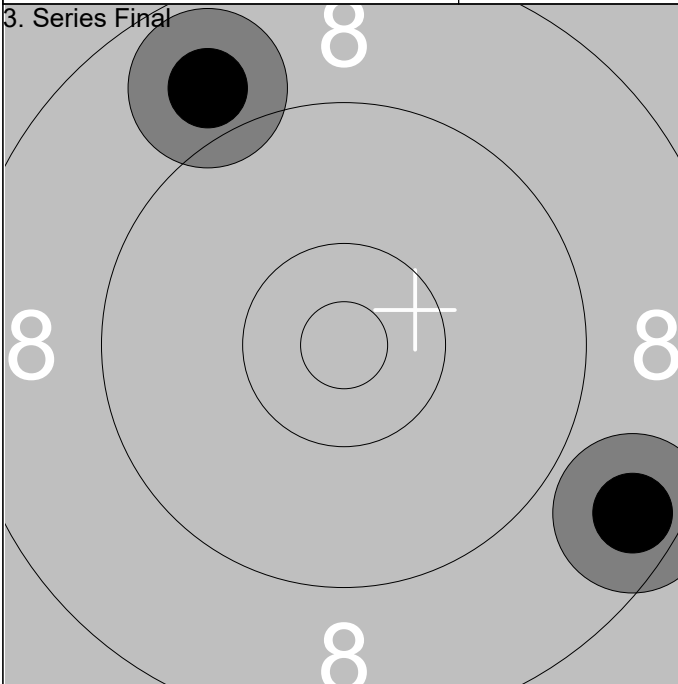

|        |   |
|--------|---|
| 1: 8.9 | ↖ |
| 2: 8.6 | ↘ |

|        |       |
|--------|-------|
| Series | 17.5  |
|        | 102.0 |

|         |   |
|---------|---|
| 1: 10.0 | ↖ |
| 2: 6.3  | ↗ |

|        |       |
|--------|-------|
| Series | 16.3  |
|        | 118.3 |

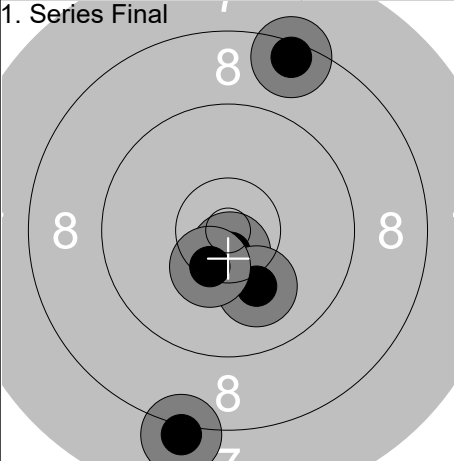
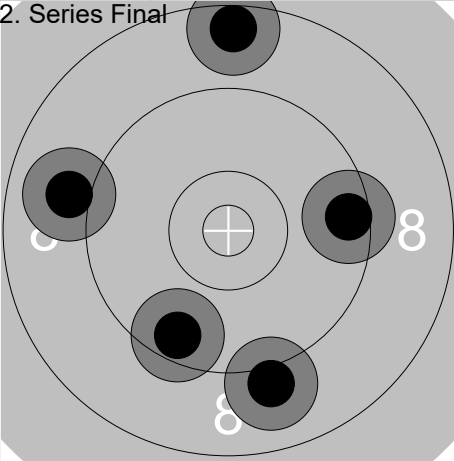
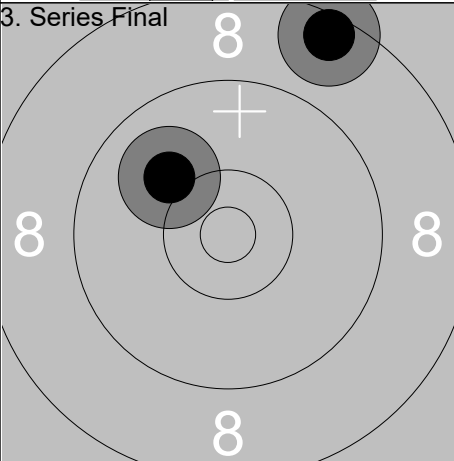
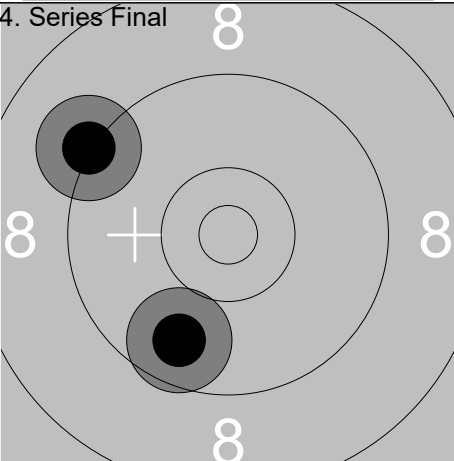
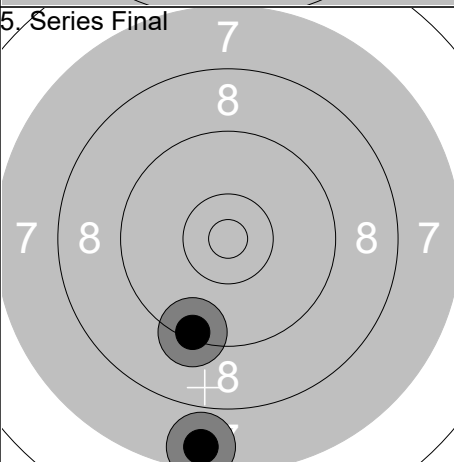
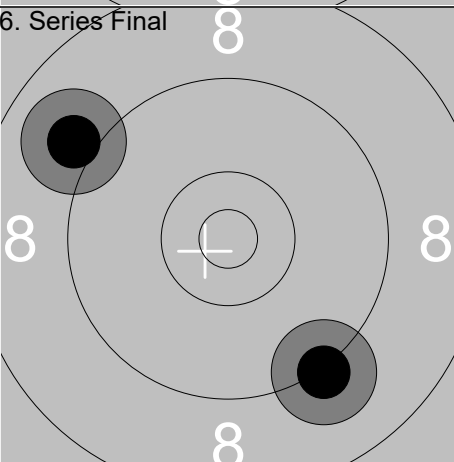
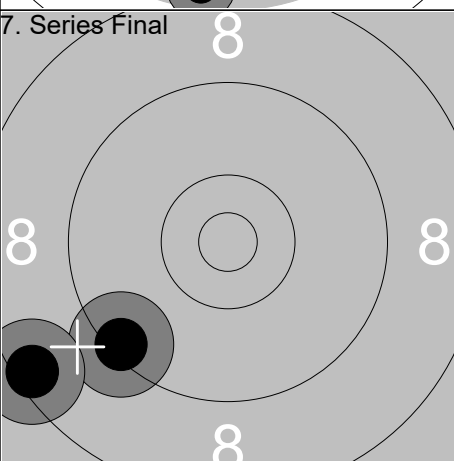
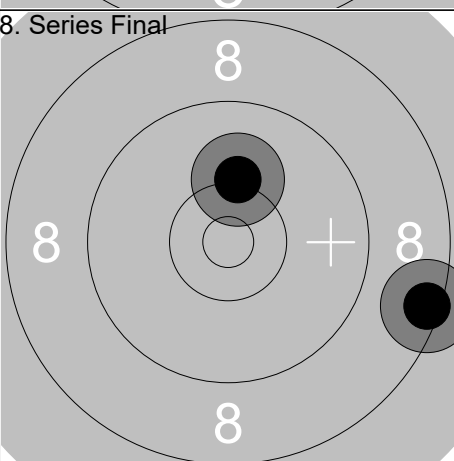
| Relay   | Lane  | Emily Shawyer  |  |
|---|---|--|--|
| Wrexham   |   |  |  |
| 02.04.2017  | Pistol Junior   | Welsh Airgun Association   |  |
| 1. Series Final   | 1: 10.7x ↓<br>2: 10.1 ↓<br>3: 8.1 ↓<br>4: 10.4x ↓<br>5: 8.4 ↑ | 2. Series Final  | 1: 8.5 ↑<br>2: 9.5 ↓<br>3: 9.0 ↓<br>4: 9.5 →<br>5: 9.0 ← |
|    | Series 47.7<br>47.7   |    | Series 45.5<br>93.2                                      |
| 3. Series Final   | 1: 10.0 ↖<br>2: 8.5 ↑   | 4. Series Final  | 1: 9.2 ↖<br>2: 9.7 ↓                                     |
|   | Series 18.5<br>111.7  |   | Series 18.9<br>130.6                                     |
| 5. Series Final   | 1: 7.6 ↓<br>2: 9.4 ↓  | 6. Series Final  | 1: 9.0 ↖<br>2: 9.2 ↓                                     |
|  | Series 17.0<br>147.6  |  | Series 18.2<br>165.8                                     |
| 7. Series Final   | 1: 9.4 ↙<br>2: 8.4 ↙  | 8. Series Final  | 1: 8.4 →<br>2: 10.2 ↑                                    |
|  | Series 17.8<br>183.6  |  | Series 18.6<br>202.2                                     |

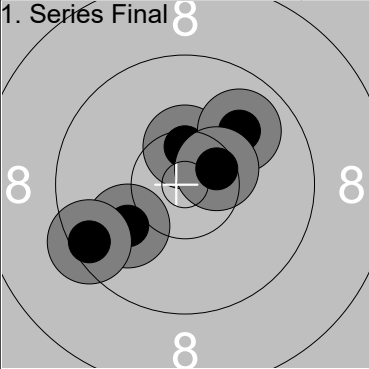
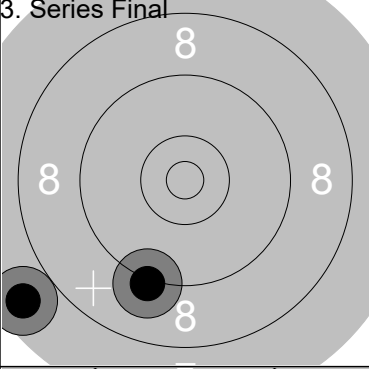
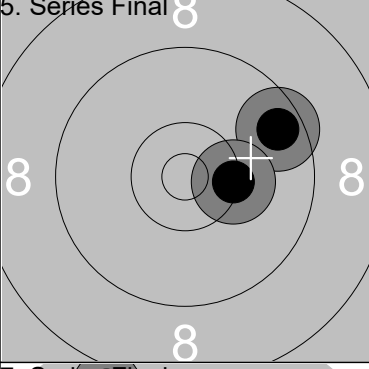
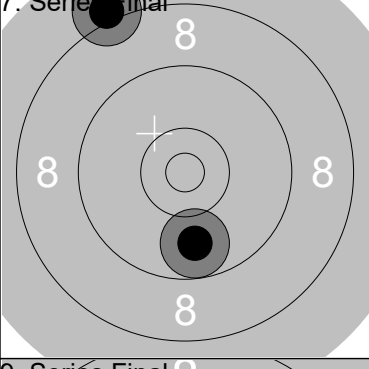
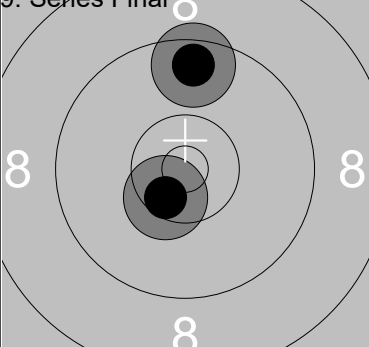
| Relay           | Lane  | Chris Glover  |   |
|-----------------|---|---|---|
| Wrexham         |   |   |   |
| 02.04.2017      | Pistol Junior   | Welsh Airgun Association                                      |   |
| 1. Series Final |    | 1: 10.0 ↙<br>2: 9.5 ↙<br>3: 10.4x ↑<br>4: 9.9 ↗<br>5: 10.5x ↗ | 2. Series Final   |
|                 | Series  | 50.3  | 1: 10.0 ↘<br>2: 9.7 ↓<br>3: 8.8 ↑<br>4: 8.7 →<br>5: 7.5 ↓ |
|                 |   | 50.3  | Series  |
|                 |   |   | 44.7  |
|                 |   |   | 95.0  |
| 3. Series Final |   | 1: 9.2 ↓<br>2: 7.7 ↙  | 4. Series Final   |
|                 | Series  | 16.9  | 1: 9.9 ↓<br>2: 10.0 ↖                                     |
|                 |   | 111.9   | Series  |
|                 |   |   | 19.9  |
|                 |   |   | 131.8   |
| 5. Series Final |  | 1: 9.6 ↗<br>2: 10.3 →   | 6. Series Final   |
|                 | Series  | 19.9  | 1: 9.5 ←<br>2: 10.4x →                                    |
|                 |   | 151.7   | Series  |
|                 |   |   | 19.9  |
|                 |   |   | 171.6   |
| 7. Series Final |  | 1: 9.8 ↓<br>2: 8.1 ↖  | 8. Series Final   |
|                 | Series  | 17.9  | 1: 10.2 ↑<br>2: 10.2 ↓                                    |
|                 |   | 189.5   | Series  |
|                 |   |   | 20.4  |
|                 |   |   | 209.9   |
| 9. Series Final |  | 1: 10.5x ↙<br>2: 9.6 ↑  |   |
|                 | Series  | 20.1  |   |
|                 |   | 230.0   |   |